



*A Design Study in High-Strength Steel Castings*

# **Intermediate Lever Arm in the BMW Engine Valve Train**



**BMW 745i Sedan**

## **Design Study Outline**

-- [Introduction](#)

-- [Designing for Performance](#)

*Alloy Selection*

-- [Designing for Castability](#)

*Molding & Casting Processes*

*Gating Design*

*Mold Configuration*

-- [Finishing and Quality Assurance](#)

-- [Lessons Learned and Summary](#)

**[Start the Design Study !](#)**  [Next](#)

### **Acknowledgment --**

*The metalcasting design studies are a joint effort of the  
Steel Founders' Society of America and the American Foundry Society .*

*Project funding was provided by the American Metalcasting Consortium Project, which is sponsored by the  
Defense Logistics Agency, Attn: DLSC-T, Ft. Belvoir, VA, 22060-6221*

[Return](#)  
[to](#)  
[SFSA](#)  
[Home](#)  
[Page](#)



Copyright 2003 by the Steel Founders' Society of America. All rights reserved.  
Address comments to: [blairr@sfsa.org](mailto:blairr@sfsa.org)  
Last Modified: October, 2003 by STG

***In cooperation with***  
[Hitchiner Manufacturing](#)



An Example in Steel Casting -- Lever Arm in the BMW Engine Valve Train

# The BMW "Valvetronic" System

**The Application** -- BMW uses an innovative variable control valve system, called "Valvetronic", in their 4, 8, and 12 cylinder engines for the BMW and Rolls Royce vehicle lines. Valvetronic engines use a combination of hardware and software to eliminate the need for a conventional throttle mechanism.

- The Valvetronic system reduces maintenance costs, improves cold start behavior, lowers exhaust emissions, and provides a smoother running engine.

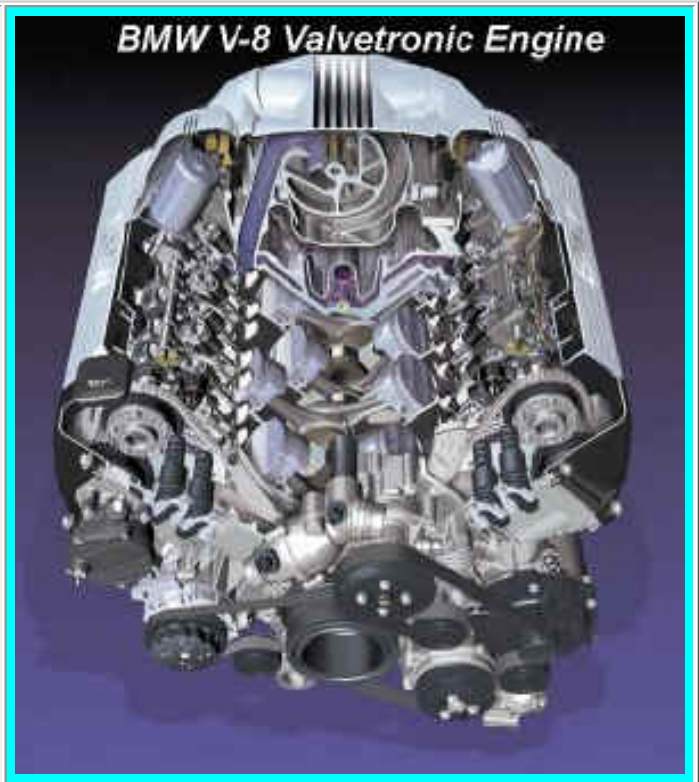

[Back](#) [Next](#)



## Valvetronic System -- Function

The Valvetronic system replaces the function of the butterfly throttle valve in the engine by using an infinitely variable intake valve with fully adjustable timing and lift.

- The system has a conventional valve camshaft, but it also uses a secondary eccentric shaft with a series of levers and roller followers, all activated by a stepper motor.
- Based on signals from the accelerator pedal and the engine sensors, the stepper motor changes the phase of the eccentric shaft, modifying the opening and closing profile of the intake valves.
- If the finger follower push deeper, the intake valves will have a higher lift, and vice-versa.

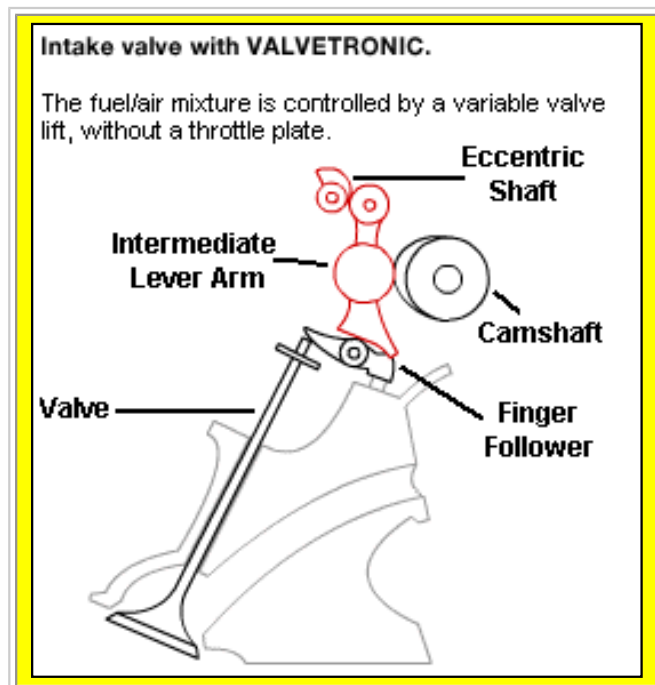

An Example in Steel Casting -- Lever Arm in the BMW Engine Valve Train

## Valvetronic System -- Operation and Performance

The Valvetronic system has the ability to get deep, long ventilation (large valve lift) and flat, short ventilation (short valve lift), depending on the demands placed on the engine.

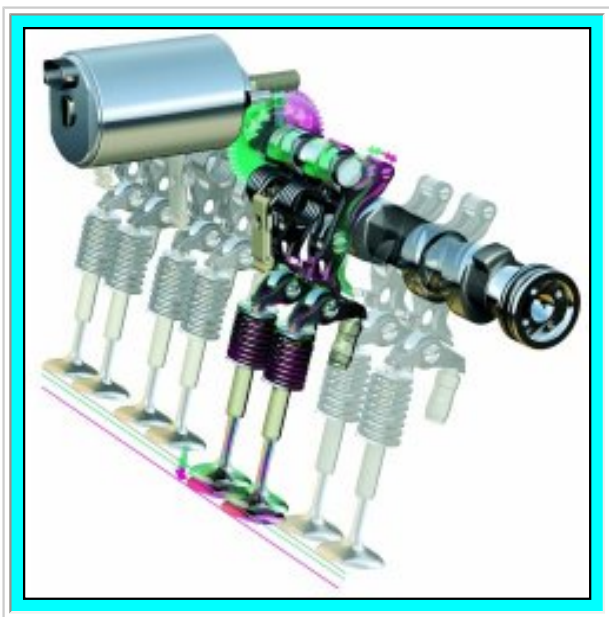

Key valve performance parameters are --

- Valve lift is variable between 0 and 9.7 mm.
- Adjustment of the sensor motor gear from one extreme to the other takes 300 milliseconds.
- Combined with double variable camshaft valve timing technology, the camshaft angle relative to the crankshaft can be adjusted by up to 60°.



## Castings in the Valve Train

Two key components of the Valvetronic valve train are produced as castings -- the intermediate lever arm and the finger follower.

- The design and production of both parts was a collaborative effort between BMW designers and Hitchiner casting engineers in New Hampshire, going from initial design to full production(10,000 pieces per day) in a 2 year cycle.
- Hitchiner also machines, finishes, and assembles the valve components with installed bearings.

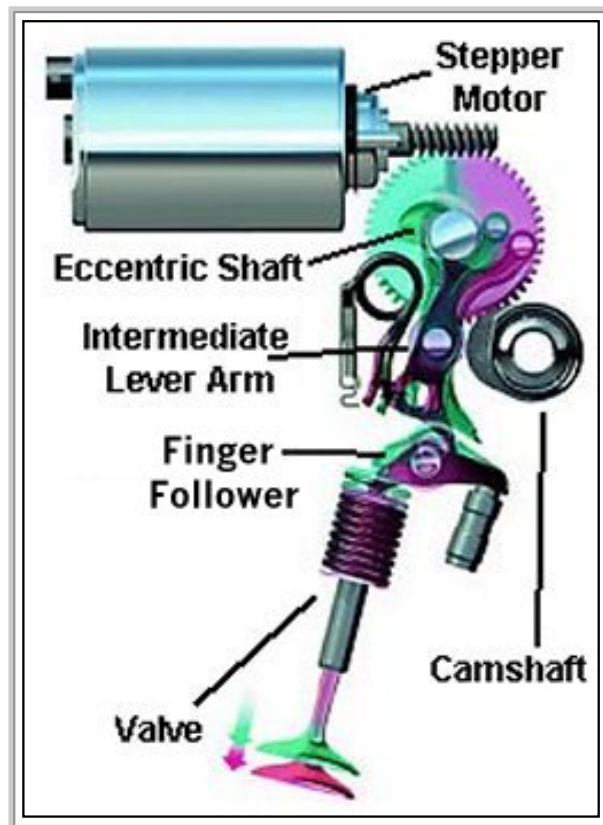

## Intermediate Lever Arm

The intermediate lever arm is a critical component in the Valvetronic system. It moves under the action of the eccentric cam to shift the finger follower pivot point and modify the valve stroke under the action of the cam shaft.

The lever arm is a 3" (7.5 cm) long steel bar with stiffening ribs, cut-outs, slots, tabs, and bearing/profile faces. The cross-section envelope of the arm is about 1" by 1".

- The thinnest wall is less than 1.5 mm thick; the thickest wall is 3 mm thick.
- The as-cast weight of the lever arm is 50 grams.
- The finished assembly weight with the bearings is 80 grams.





## Lever Arm Performance Requirements



The intermediate lever arm is a precision component designed to minimize the weight and inertia in the valve train, but still provide high strength and stiffness.

The lever arm has to withstand high cyclic stresses and aggressive wear conditions over the full life of the engine, requiring a steel alloy that has:

- Ultimate Tensile Strength = 263 ksi / 1870 MPa
- Yield Stress = 242 ksi / 1670 MPa
- Surface hardness of 70 Rockwell C measured with a Vickers microhardness tester
- Core hardness of 37 Rockwell C

The precise mechanical action in the valve train depends on tight tolerances on the critical dimensions of the lever arm -- +/-0.05 mm.

- Finished components are 100% inspected and classed into six tolerance bands, each 8 microns wide. Classed parts are used as matched sets in individual engines.
- Appearance -- Uniform, blemish free appearance with an oxidation layer after plasma nitriding.



## Manufacturing Challenges

Two production options were considered for the production of the lever arm -- casting and forging.

- The production requirement is 2.5 million lever arms per year with requirements for precision tolerances, controlled cost, and minimal machining. (The steel alloy is very hard with limited machinability.)
- With those requirements casting is the production method of choice.
  - Casting produces a near-net shape component with the minimal amount of additional machining.



*Hitchiner Manufacturing produces 10,000-12,000 finished lever arm assemblies every day.*

The challenge in manufacturing this component was to select the best metal alloy and optimize the casting design to meet the performance and production targets:

- *Achieving high strength, wear resistant alloy performance.*
- *Meeting the required dimensional tolerances for fit and function.*
- *Producing a high quality, flaw free part on-time and at-cost.*



[Back](#) [Next](#)

8



[Return to SFSA](#)  
[Home Page](#)

Copyright 2003 by the Steel Founders' Society of America All rights reserved.  
Address comments to: [blairr@sfsa.org](mailto:blairr@sfsa.org)  
Last Modified: October, 2003 by STG



[Page 1](#)

In cooperation with  
[Hitchiner Manufacturing](#)





## The Casting Design Issues

The casting design engineers at the Hitchiner Manufacturing had three imperatives for an integrated casting design.

- *Design for Performance*
- *Design for Castability*
- *Design for Cost*

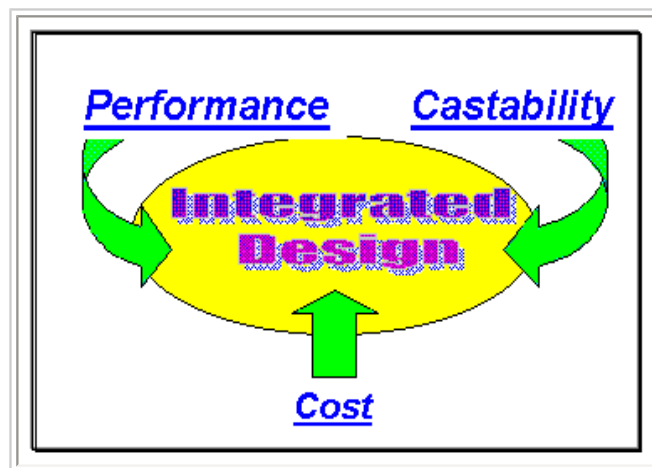

**Critical Casting Design Issues** --The requirements for performance, castability, and cost are closely interconnected. Four casting design issues played a major role in meeting the three design imperatives

- Select the [steel alloy](#) that meets the strength and wear resistance requirements.
- Select the [molding and casting processes](#) to insure part quality and control costs.
- Design the [gating system](#) to produce sound castings.
- Develop the [mold configuration](#) to optimize metal flow and maximize loading.



## Alloy Selection

In the original design, BMW needed a hardness of 50-56 Rockwell C and specified an 8640 steel alloy (iron-carbon with manganese, chromium, nickel, and molybdenum) for the castings.

- But when test components went into engine testing, six months before full production, the original specified alloy had wear problems on the eccentric shaft.
- Engine tests 3 months prior to production on the modified shaft indicated wear on the intermediate lever arm. The alloy on the intermediate lever arm had to be changed to be compatible with the new shaft.



**BMW and Hitchiner engineers worked together to respond to this unexpected challenge, doing a joint study to choose and test an alternate alloy with higher hardness and improved required wear resistance.**

**The development team chose and validated a European alloy -- a 30Cr-MoV9 tool steel -- to meet the performance requirements of the lever arm. A plasma nitriding treatment produces hard, wear resistance surface layers on the casting.**

*There was one negative factor with the new alloy -- lower yield. The 30CR-MoV9 steel has lower fluidity which required higher casting temperatures for good fill. Higher temperatures required longer solidification time, which increased the casting time and produced fewer daily casting cycles.*



## Molding Process Selection

In considering the physical size, production quantity, complexity, tolerance requirements, and cost targets for the lever arm component, **lost-wax investment casting** was the molding process of choice.



Ceramic Shell Mold

The lost-wax investment casting process--

- Uses a mold formed by coating a wax pattern with a ceramic to form a shell mold.
- Provides exceptionally fine detail and excellent dimensional tolerance.
- Has high volume production capacity.



## Lost Wax Investment Casting

The basic steps of the investment casting process are:

1. Production of heat-disposable wax or plastic patterns in a precision tool.
2. Assembly of these patterns onto a gating system.
3. "Investing," or covering the pattern assembly with ceramic to produce a monolithic mold.
4. Melting out the wax pattern assembly to leave a precise mold cavity. Firing the ceramic mold to cure the ceramic mold.
5. Preheating the mold for casting and pouring the metal into the mold.
6. Knockout, cut-off, finishing, and inspection of the casting.

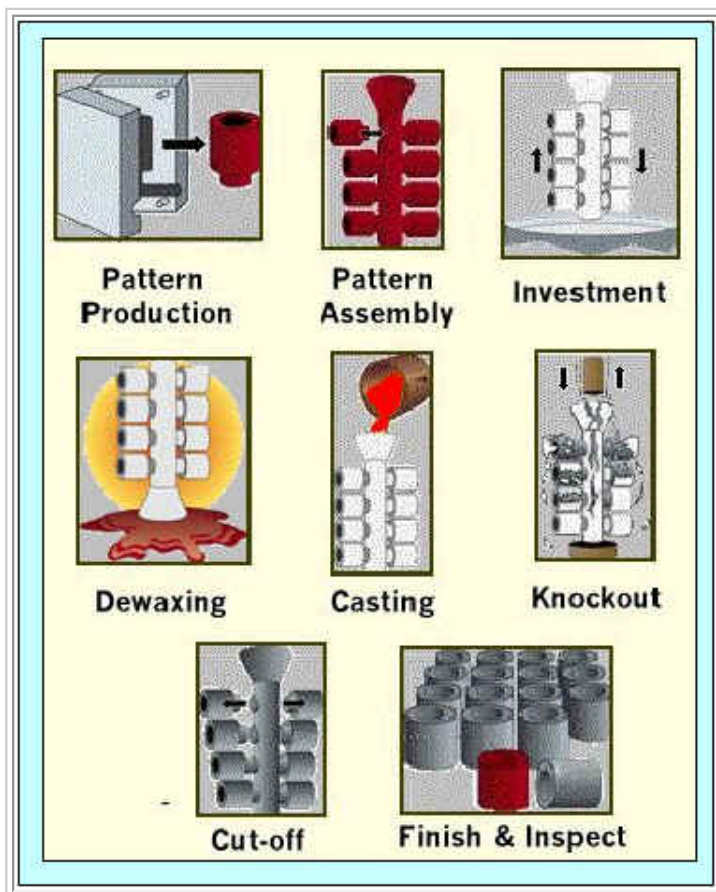

## Casting Process Selection

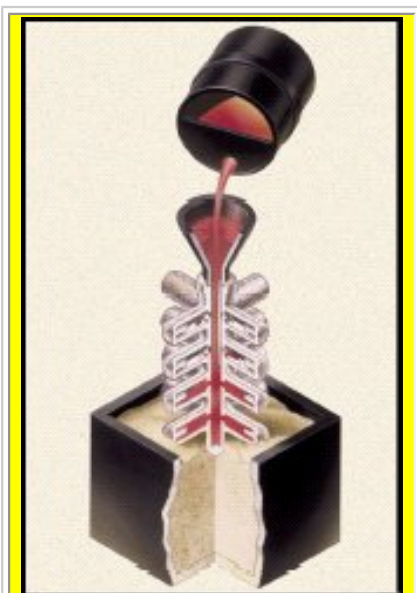

Conventional Gravity Investment Casting

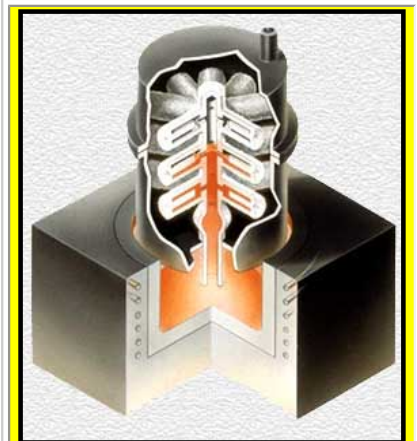

Countergravity Low-Pressure Air (CLA) Investment Casting

With the selection of investment casting, Hitchiner engineers faced two specific challenges in casting the lever arm.

1. The lever arm has many detailed and precision features and fill-out is challenging.
2. Metal yield must be maximized by minimizing metal retained in the gating system.

Hitchiner engineers had two investment casting processes from which to choose--

- . *Conventional Gravity Casting*
- . *Countergravity Low-Pressure Air (CLA)*





## Countergravity Low-Pressure Air (CLA)

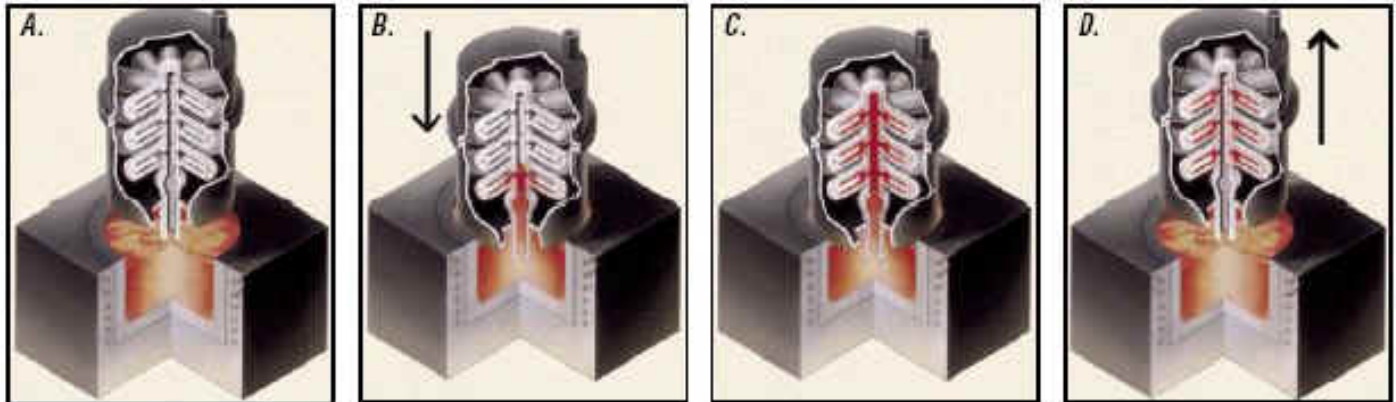

**In CLA casting, the casting process consists of four major steps.**

- A.** The permeable mold is positioned in a closed chamber with a vacuum valve. An open, impermeable sprue pipe at the base of the mold extends down out of the chamber.
- B.** The sprue pipe of the mold is lowered into the molten metal in the crucible. An applied vacuum draws the molten metal up into the mold cavity in a controlled flow.
- C.** The molten metal fills the mold cavity and the castings solidify, while the central sprue stays molten.
- D.** When the vacuum is released, the still molten metal in the central sprue returns to the crucible for reuse. The chamber is raised, and the separate, solid castings remain in the mold.

**After cooling, the mold with the castings is removed from the chamber. The individual, free-standing castings are removed from the mold.**





## Conventional Gravity Casting

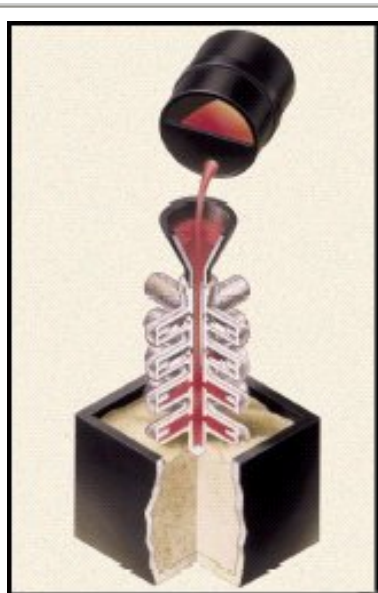

Gravity Casting

In gravity casting the melting and pouring process consists of two steps in an open atmosphere.

1. Heat the metal in the crucible to the casting temperature.
2. Tilt the crucible and pour the liquid metal into the mold.

Allow the mold and casting to cool. Remove the ceramic mold, leaving individual castings connected to the central sprue and gate system.

Which casting process ([Conventional Gravity](#) or [Countergravity Low Pressure Air - CLA](#)) is best suited for producing the lever arms?



[Back](#)

Choose a casting process

15



[Return to SFSA Home Page](#)

Copyright 2003 by the Steel Founders' Society of America All rights reserved.  
Address comments to: [blairr@sfsa.org](mailto:blairr@sfsa.org)  
Last Modified: October, 2003 by STG



[Page 1](#)

In cooperation with [Hitchiner Manufacturing](#) 

## Conventional Gravity Casting

**Conventional gravity casting poses several shortcomings in producing the lever arms.**

- In gravity casting, solidified metal in the down sprue dramatically increases alloy usage and cost, compared to CLA.
- Variability (from one pour to the next) of metal flow into the mold cavities makes reliable casting fill-out difficult.
- Metal flow is much more turbulent, increasing the chance for trapped gas and oxide inclusions.

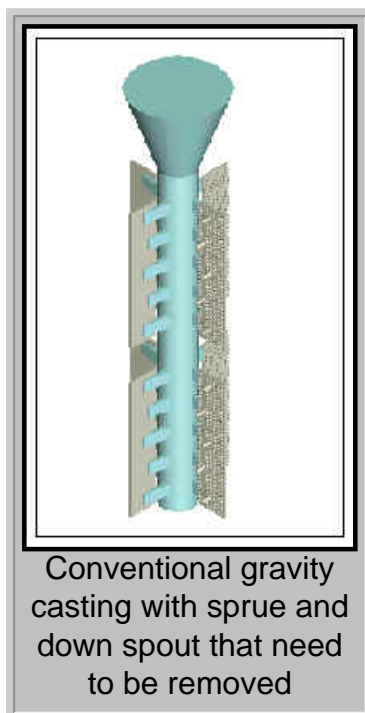

**Gravity casting *is not* the best process for the lever arms.  
[Go back to the Process Selection Page](#)**



[Back](#)

16



[Return to SFSA Home Page](#)

Copyright 2003 by the Steel Founders' Society of America All rights reserved.  
Address comments to: [blairr@sfsa.org](mailto:blairr@sfsa.org)  
Last Modified: October, 2003 by STG



[Page 1](#)

**In cooperation with**  
**[Hitchiner Manufacturing](#)** 

An Example in Steel Casting -- Lever Arm in the BMW Engine Valve Train

## Countergravity Low Pressure Air (CLA)

Countergravity low pressure air (CLA) casting has several advantages in producing the lever arms.

- The differential pressure under which the metal is drawn into the mold ensures fill-out of very thin sections and fine surface details in the mold.
- Metal flow is less turbulent, reducing oxide inclusions and other turbulence-related defects.
- Return of the molten metal from the sprue and gates to the crucible following casting improves casting-to-gate ratios and dramatically reduces alloy costs.



[QuickTime Video of CLA Casting \(2.0 Meg\)](#)  
[Download QuickTime Viewer](#)



**CLA is the best casting process for the lever arm.**  
**[Go to the Next Design Issue](#)**



[Back](#) [Next](#)



## Gating Design

The gates into the casting serve as the path by which molten metal flows into the mold cavity and feeds the shrinkage which develops during casting solidification.

Proper design of the gating system is critical in meeting two important requirements.

- Short flow paths and controlled metal flow prevents casting misruns due to premature solidification.
- Relatively heavy and thick sections which will solidify more slowly require direct contact with the gating to provide molten metal for feeding shrinkage during solidification.

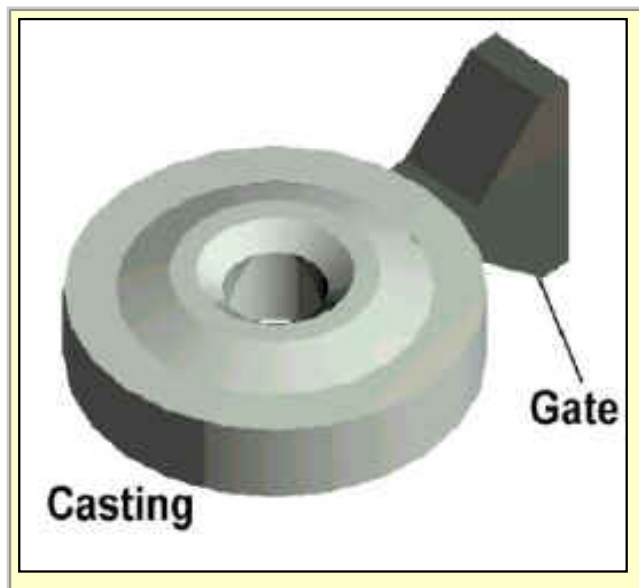

## Gating Design

Two different gating designs for the lever arm are shown to the right --

- [Option A](#) -- Two wide gates into the center sections of the lever arm
- [Option B](#) -- One narrow gate into the foot of the lever arm

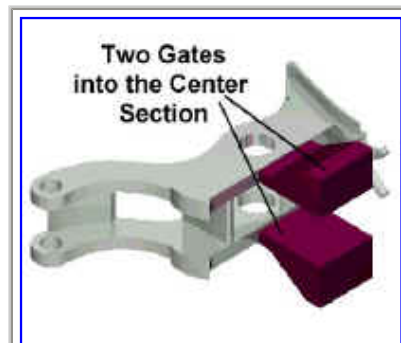

[Option A](#) -- Two gates into the center sections of the lever arm



[Option B](#) -- One gate into the foot of the lever arm

*Choose the gating system*

*([Option A](#) or [Option B](#))*

*which provides the best metal flow into the casting cavity*

 [Choose an Option](#)  
[Back](#)

19



[Return to SFSA Home Page](#)

Copyright 2003 by the Steel Founders' Society of America All rights reserved.  
Address comments to: [blair@sfsa.org](mailto:blair@sfsa.org)  
Last Modified: October, 2003 by STG



[Page 1](#)

*In cooperation with*  
[Hitchiner Manufacturing](#) 

An Example in Steel Casting -- Lever Arm in the BMW Engine Valve Train

## Option A -- Gating into the Center of the Lever Arm

In Option A, two gates feed into the center section of the lever arm. This gating design is good for three reasons:

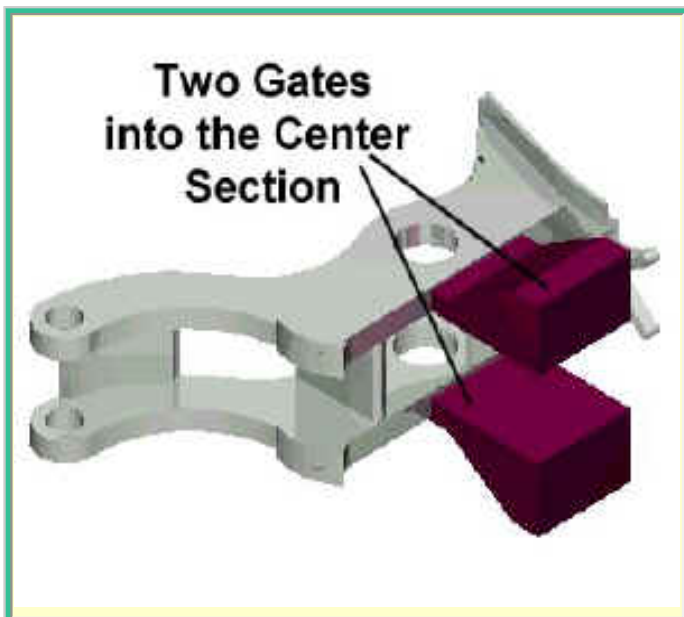

- The distance the metal needs to flow into the casting is minimized, reducing the risk of misruns and unfilled sections.
- Solidification will start at the far ends of the casting and will proceed towards the heavier center sections, producing a sound casting.
- The gates feed directly into the center sections of the casting (which would be the last to solidify) providing good metal feed during solidification.

With two gates on the center bars, three process issues have to be considered.

- Because of the tolerance requirements on the in-gate surface, laser cutting is the best method for gate removal.
- Because there are two gates, two cutting operations are necessary.
- A variation in solidification times between interconnected gates and the part are a potential cause of distortion. The "stickless" (no sprue) casting approach eliminates this problem.

**Option A is the preferred gating system design**  
**[Go to the next design issue](#)**





An Example in Steel Casting -- Lever Arm in the BMW Engine Valve Train

## Option B -- Gating into the Foot of the Lever Arm

In Option B, one narrow gate feeds into the foot of the lever arm. This gating approach is not preferred because:

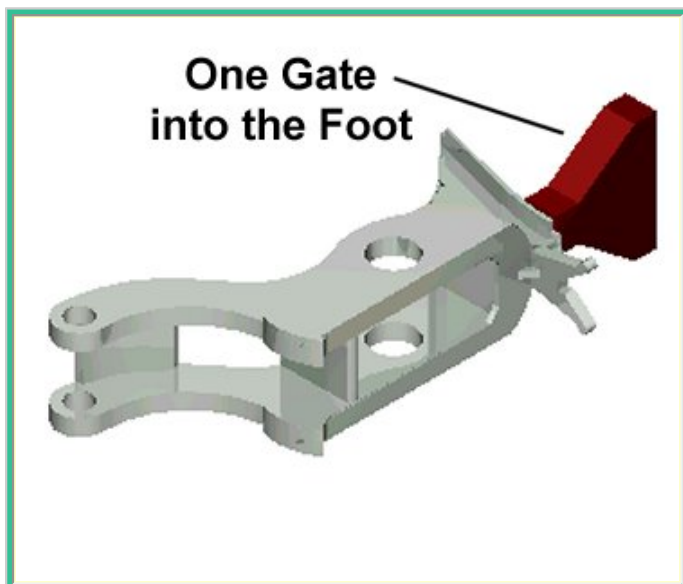

- The metal feeds into the far end of the casting and has a long run into the opposite end, risking misruns and unfilled sections.
- The narrow gate will produce faster, more turbulent metal flow
- The center section will be isolated from the gate and may solidify without adequate liquid metal feed, risking solidification shrinkage.

*Option B is not the preferred gating design*  
[Go Back to the Gating Design Page](#)



[Back](#)

21



[Return to SFSA Home Page](#)

Copyright 2003 by the Steel Founders' Society of America All rights reserved.  
Address comments to: [blairr@sfsa.org](mailto:blairr@sfsa.org)  
Last Modified: October, 2003 by STG



[Page 1](#)

In cooperation with [Hitchiner Manufacturing](#)



## Mold Configuration and Orientation

The orientation of the parts in the investment mold is an important factor in wax removal, metal flow control, thermal management, and high metal yield.

The part should be oriented in the mold so that:

- wax can flow freely out of individual cavities and is not trapped in the mold during dewaxing.
- metal flows uniformly and smoothly into the cavity without dropping or splashing.
- Parts are close packed on the tree for uniform heating and cooling and volume efficiency (high yield).



[Option A](#) -- Horizontal Orientation of Wax Patterns on Sprue

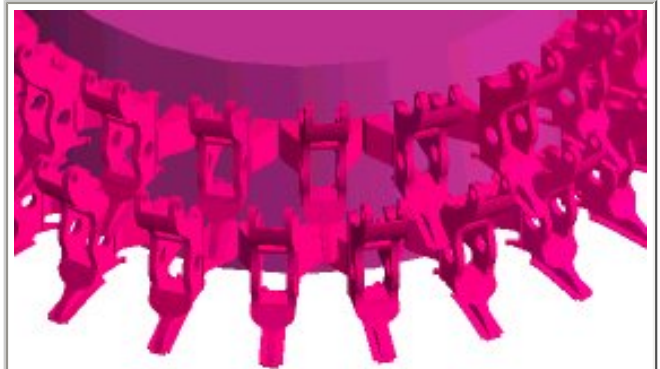

[Option B](#) -- Vertical Orientation of Wax Patterns on Sprue

*The lever arms can be positioned in the mold with a vertical or a horizontal orientation relative to the sprue.*

Choose the casting orientation ([Option A](#) or [Option B](#)) which simplifies wax removal, provides smooth and direct metal flow, and maximizes yield.

[Choose an Option](#)  
[Back](#)



## Option A - Horizontal Orientation

In Option A, the lever arms are oriented horizontally in the mold in relation to the sprue.



Option A - Horizontal Orientation of Wax Patterns on Sprue

This orientation has good part packing and volume efficiency. It also promotes sound castings without flaws.

- Wax in the cavity can melt and flow out of cavity through the gate easily because there are no trapping zones below the gate. Trapped wax can cause porosity in the casting.
- When the metal flows into the cavity, the horizontal orientation will provide for smooth, uniform flow into all sections of the cavity, minimizing turbulence and splashing.

**Option A is the best part orientation.**  
***Go on to the Next Design Issue***



[Back](#) [Next](#)

23



[Return to SFSA Home Page](#)

Copyright 2003 by the Steel Founders' Society of America. All rights reserved.  
Address comments to: [blairr@sfsa.org](mailto:blairr@sfsa.org)  
Last Modified: October, 2003 by STG



[Page 1](#)

In cooperation with [Hitchiner Manufacturing](#)



## Option B - Vertical Orientation

In Option B, the lever arms are oriented vertically in the mold in relation to the sprue.

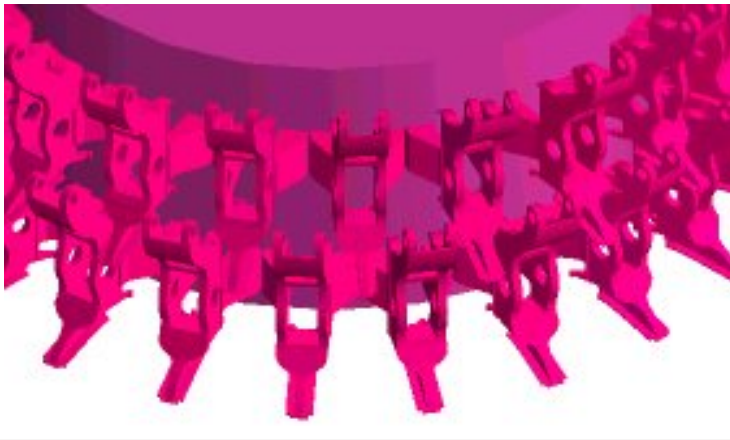

Option B - Vertical Orientation of Wax Patterns on Sprue

This orientation has good part packing and volume efficiency, but it has two shortcomings.

- Wax in the lower half of the individual cavities cannot escape easily and will be trapped in the lower portion of the mold cavity, possibly causing gas holes in the casting.
- When the metal flows into the cavity, the vertical drop from the gates will cause splashing and turbulent flow, which can produce casting flaws.

**Option B is not the best part orientation.**  
**[Go Back to the Mold Orientation Page](#)**



[Back](#)

24



[Return to SFSA Home Page](#)

Copyright 2003 by the Steel Founders' Society of America All rights reserved.  
Address comments to: [blairr@sfsa.org](mailto:blairr@sfsa.org)  
Last Modified: October, 2003 by STG



[Page 1](#)

In cooperation with  
[Hitchiner Manufacturing](#)



An Example in Steel Casting -- Lever Arm in the BMW Engine Valve Train

## Pattern Assembly and Investment

Pattern production for the BMW lever arm begins with the fabrication of an individual wax pattern in an aluminum tool.



Wax Pattern for Lever Arm

Two hundred and forty-three wax patterns are assembled on a 6" diameter sprue to form the casting tree. ( Partial pattern assembly shown to the right)

The tree is then invested (coated) with ceramic by dipping the tree into a ceramic slurry bath.

After wax removal, the finished mold is placed in the casting chamber and the chamber is back filled with a 22 mesh mullite sand.

- The sand in the chamber supports the mold and reduces the number of investments needed, saving production time.
- The sand also improves thermal uniformity and heat management in the mold chamber.



Partial Pattern Assembly before Investment



[Back](#) [Next](#)

25



[Return to SFSA Home Page](#)

Copyright 2003 by the Steel Founders' Society of America All rights reserved.  
Address comments to: [blairr@sfsa.org](mailto:blairr@sfsa.org)  
Last Modified: October, 2003 by STG



[Page 1](#)

In cooperation with [Hitchiner Manufacturing](#)





## Investment Casting

The finished mold is placed in the casting chamber and the counter gravity low vacuum casting process begins.

1. The permeable mold is positioned in the chamber and backfilled with sand.
2. The sprue pipe of the mold is lowered into the molten metal in the crucible. An applied vacuum draws the molten metal up into the mold cavity in a controlled flow.
3. The molten metal fills the mold cavity and the castings solidify, while the central sprue stays molten.
4. When the vacuum is released, the still molten metal in the central sprue returns to the crucible for reuse. The chamber is raised, and the separate, solid castings remain in the mold.
5. After cooling, the mold with the castings is removed from the chamber. The individual, free-standing castings are removed from the mold.

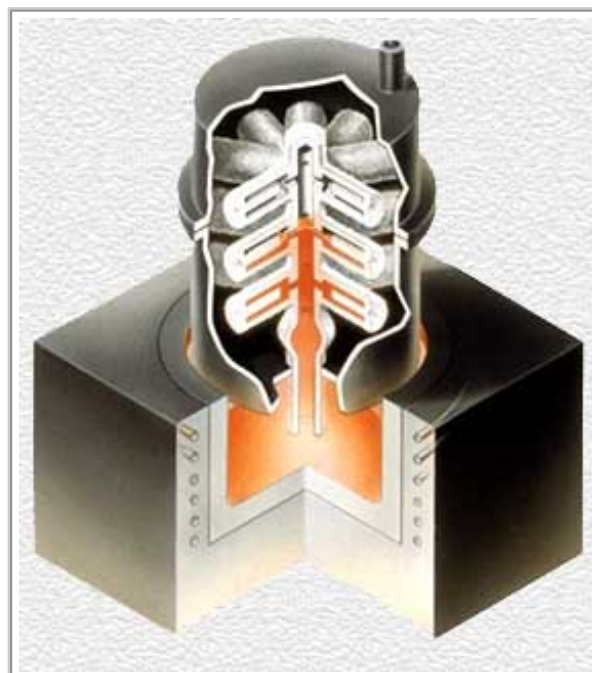

Counter Gravity Low Pressure Air Investment Casting





## Clean, Cut, Anneal, and Machining



Automated Boring Operation

After ceramic shell removal, the lever arm castings go through several operations to prepare for precision machining, surface treatments, and inspection.

- Castings are abrasive blasted and caustic cleaned to remove shell sand residue.
- The gate stubs are laser cut off.
- The castings are annealed in methane for carbon restoration
- The two bearing holes are bored to a 50 micron tolerance.



An Example in Steel Casting -- Lever Arm in the BMW Engine Valve Train

## Heat Treat and Finish Machining



The lever arm is heat-treated and tempered to develop the required microstructure and base hardness.

After heat-treatment, three features on the lever are finish machined.

- The two bearing holes are honed to a 20 micron tolerance.
- The two bearing pads are ground to a tolerance of 30 microns.
- The profile is ground to a tolerance of 30 microns.



[Video of the Honing Operation](#)  
[Download Real Player](#)

After finish machining the parts are vibro-cleaned and washed.



## Plasma Nitriding



Component in Plasma Nitriding Chamber  
(from Rubig Plant Technology)

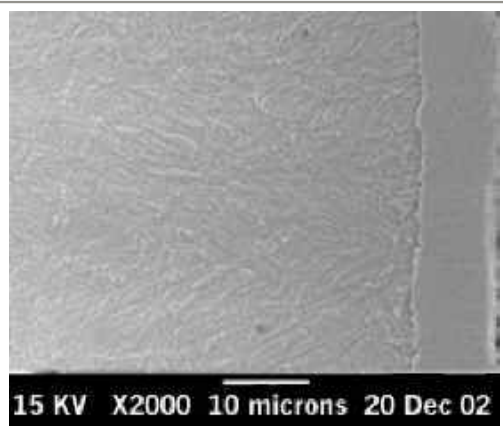

Microstructure of Nitrided Surface Layer (to the right)

The wear resistance and durability of the lever arm are enhanced by a plasma nitridation which develops a hard surface layer on the entire component.

- Plasma nitriding (also known as ion nitriding) is a low temperature, low distortion surface engineering process.
- A D.C discharge plasma is used to transfer nitrogen to the surface of the components at temperatures between 400°C and 750°C at low gas pressures.
- The nitriding process produces a nitride rich surface layer with high surface hardness and hardened depths up to 0.8mm with minimal high temperature distortion of the component.

[Video of Plasma Nitriding](#)  
[Download Real Player](#)



[Back](#) [Next](#)

29



[Return to SFSA Home Page](#)

Copyright 2003 by the Steel Founders' Society of America All rights reserved.  
Address comments to: [blairr@sfsa.org](mailto:blairr@sfsa.org)  
Last Modified: October, 2003 by STG



[Page 1](#)

In cooperation with [Hitchiner Manufacturing](#)

## Quality Assurance

The dimensional tolerances on the lever arm are critical to the operation of the engine valve train. Dimensional and casting quality are checked at five points in the casting process.

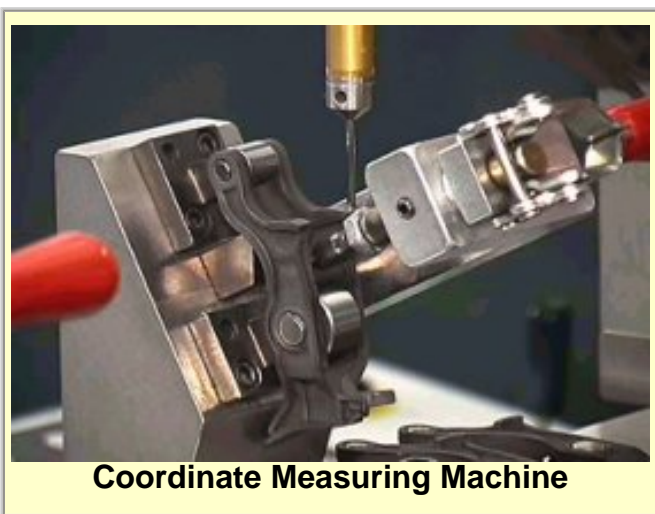

Coordinate Measuring Machine

- Critical dimensions on the wax pattern are checked prior to pattern assembly.
- Critical tolerances on the bearings are automatically measured.
- The slope of the profile is gauged and the lever arms are classified into six tolerance bands (8 micron span) so that matched sets are installed into a given engine.
- The alignment and contour of the bearing pads are 100% inspected by a coordinate measuring machine.
- The casting is visually inspected for surface quality and bearing operation after assembly.



[Back](#) [Next](#)

30



[Return to SFSA Home Page](#)

Copyright 2003 by the Steel Founders' Society of America All rights reserved.  
Address comments to: [blairr@sfsa.org](mailto:blairr@sfsa.org)  
Last Modified: October, 2003 by STG



[Page 1](#)

In cooperation with  
[Hitchiner Manufacturing](#) 

## Lessons Learned

The design and production effort for the lever arm was a short cycle project going from starting concept to full production in two years.

### Major lessons learned were --

- Concurrent, integrated engineering was essential to meet the product goals and schedule. Interaction between Hitchiner and BMW engineers was critical right from the start.
- There were many design iterations in the process, and strong communication between the two teams was essential to meet the dynamic quality, schedule and cost targets.
- Concurrent engineering must be responsive to unexpected challenges.
  - In the first prototype qualification test, the original alloy produced excessive wear on another component. This was found 3 months before production and required a crash program to identify an appropriate alloy with higher hardness.



## Summary

# Intermediate Lever Arm in the BMW Valve Train

Hitchiner Manufacturing is producing the two BMW valve components (lever arm and finger follower) at a rate of 2.5 million assemblies per year.

The demanding tolerances and the required high reliability could only be produced economically by precision investment casting.



For further information on the production of this and other investment castings, contact

**Gary Scholl at Hitchiner Manufacturing**

Phone-- 603-673-9720, X1575    E-mail: [gwscholl@mct-inc.com](mailto:gwscholl@mct-inc.com)

Web Site = <http://www.hitchiner.com>

### Acknowledgment --

*The metalcasting design studies are a joint effort of the Steel Founders' Society of America and the American Foundry Society. Project funding was provided by the American Metalcasting Consortium Project, which is sponsored by the Defense Logistics Agency, Attn: DLSC-T, Ft. Belvoir, VA, 22060-6221*



[Back One](#)

*The End*

32



[Return to SFSA Home Page](#)

Copyright 2003 by the Steel Founders' Society of America All rights reserved.  
Address comments to: [blairr@sfsa.org](mailto:blairr@sfsa.org)  
Last Modified: October, 2003 by STG



[Top](#)

[Hitchiner Manufacturing](#)

