



A Design Study in Steel Casting

Pintle Socket for River Lock Gates

Design Study Outline

[Introduction](#)

[Designing for Performance](#)

Alloy Selection

[Designing for Castability](#)

Design Feature Analysis

Mold and Core Design

Solidification Control

Patterns and Cores

[Machining Considerations](#)

[Lessons Learned and Summary](#)

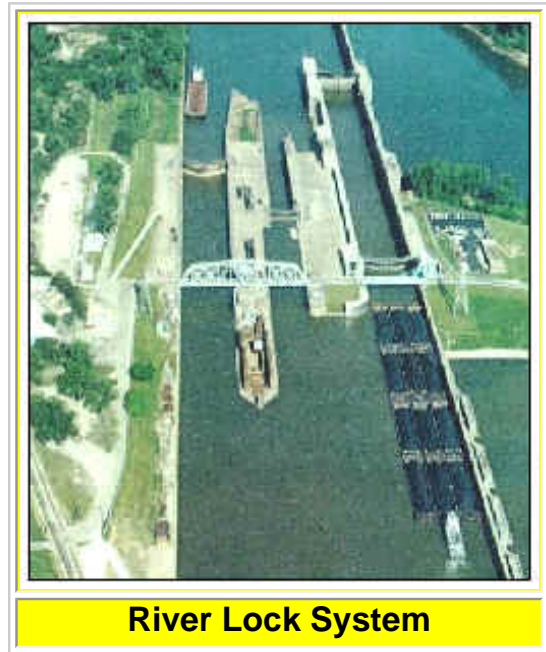

Start the Design Study !



Acknowledgment --

*The metalcasting design studies are a joint effort of the
Steel Founders' Society of America and the American Foundry Society.*

*Project funding was provided by the American Metalcasting Consortium Project, which is sponsored by the
Defense Logistics Agency, Attn: DLSC-T, Ft. Belvoir, VA, 22060-6221*

[Return to SFSA Home Page](#)



Copyright 2001 by the Steel Founders' Society of America
All rights reserved.
Address comments to: blairr@sfsa.org
Last Modified: September, 2001 by STG

In Cooperation with [Atchison Casting](#)

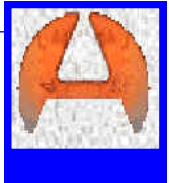



A Design Study in Steel Castings -- Pintle Socket

Pintle Socket - Application

- The locks on a river serve as a transport system for moving barges and boats up and down past waterfalls and dams. The lock consist of a large chamber in which water is pumped into and out of to raise and lower the river craft.
- Large gates at both ends of the lock chamber open and close by electric or hydraulic power to permit entry and exit of the watercraft.



Gates on the River Lock

Atchison Casting was selected as the producer for the castings for the gate system for the new chamber in the McAlpine lock system on the Ohio river at Louisville, KY.

- *The new McAlpine main lock will be 1200 feet long and 110 feet wide with a 37 foot lift.*
- *The McAlpine locks are owned and operated by the U.S. Army Corps of Engineers as part of their civil works and inland water navigation system.*



Oregon Iron Works in Clackamas, Oregon is the general contractor for the gate system.



[Back](#) [Next](#)

[Return to SFSA Home Page](#)



Copyright 2001 by the Steel Founders' Society of America
All rights reserved.
Address comments to: blairr@sfsa.org
Last Modified:September, 2001 by STG



[Page 1](#)

In Cooperation with Atchison Casting

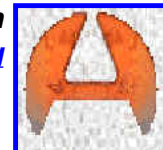



A Design Study in Steel Castings -- Pintle Socket

Pintle Socket

Function and Design



Gates under Construction

The gates are comprised of gate panels (the “doors” on the gate) and the hinge/support system, with two panels for each of the two gates (upstream and downstream) on the lock.

Each gate panel for the lock is 61 feet wide and 68 feet high with a weight of 300 tons.

The gate panel is supported and controlled by the hinge system which uses 11 castings.

Pintle sockets sit at the top and bottom corners of each gate panel.

The pintle sockets act as pivot and support points for opening and closing the gate panels.

The pintle socket castings are key components in the hinge system. The hemispherical pintle bearings sit in the pintle sockets; the gate panels are attached to the pintle sockets

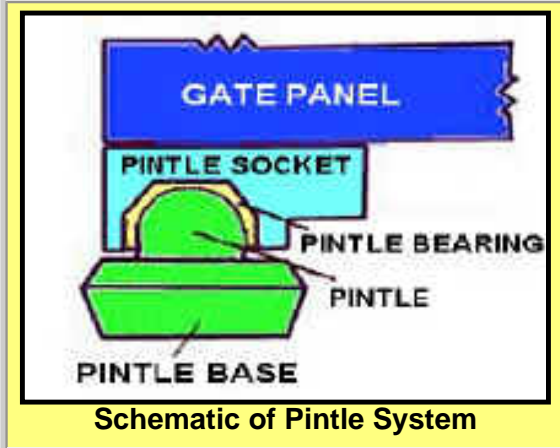

Schematic of Pintle System



[Back](#) [Next](#)

3

[Return to SFSA Home Page](#)



Copyright 2001 by the Steel Founders' Society of America
All rights reserved.
Address comments to: blairr@sfsa.org
Last Modified: September, 2001 by STG



[Page 1](#)

In Cooperation with
[Atchison Casting](#)





A Design Study in Steel Castings -- Pintle Socket

Pintle Socket -- Description

- The pintle socket is designed as a 30" diameter bowl attached to a flat plate with flanges. The plate and bowl connection is reinforced by eight rib sections around the circumference of the bowl.
- The socket is approximately 20" tall with a foot print of 54" by 43" and is cast in low carbon steel.
- The clean casting weight is 3,676 pounds; after rough machining, the weight is 3,124 pounds. The finished machined weight is 2,500 pounds.

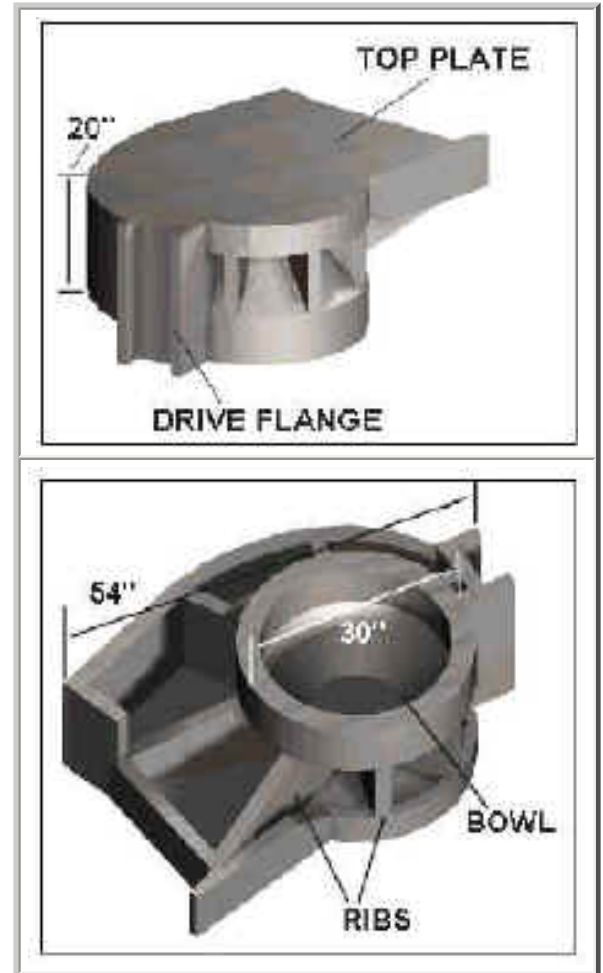

[Back](#) [Next](#)

4

[Return to
SFSA
Home
Page](#)



Copyright 2001 by the
Steel Founders' Society of America
All rights reserved.
Address comments to: blairr@sfsa.org
Last Modified: September, 2001 by STG



[Page 1](#)

In Cooperation with
[Atchison Casting](#)





A Design Study in Steel Castings -- Pintle Socket

The Casting Design Issues

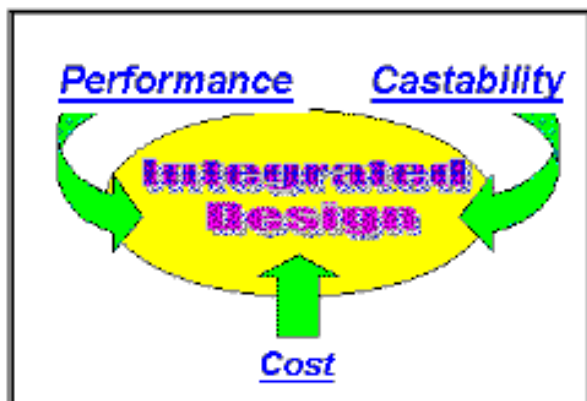

The Casting Design Approach -- The casting process engineers at Atchison Casting chose gravity casting with "no-bake" sand molds and cores. The engineers had three imperatives for an integrated casting design.

- *Design for Performance*
- *Design for Castability/Manufacturability*
- *Design for Cost*

Critical Casting Design Issues --The requirements for performance, castability/manufacturability, and cost are closely interconnected. Four casting design issues played a major role in meeting the three design imperatives

- Select the *steel alloy* that meets the strength requirements with minimum cost.
- Design for *casting soundness* in critical machined and high stress regions.
- Insure that *dimensional tolerances and quality requirements* are met.
- Minimize *manufacturing costs* considering both raw materials and production costs.

==> Weight savings were not a primary engineering issue for this component.



[Back](#) [Next](#)

5

[Return to SFSA Home Page](#)



Copyright 2001 by the Steel Founders' Society of America
All rights reserved.
Address comments to: blairr@sfsa.org
Last Modified: September, 2001 by STG



[Page 1](#)

In Cooperation with [Atchison Casting](#)

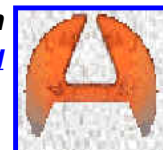



A Design Study in Steel Castings -- Pintle Socket

Steel Alloy Selection

The customer originally requested an A27 70-36 steel alloy.

- A27 (70-36) has a maximum of 0.35% carbon and 0.70% manganese with an ultimate tensile strength of 70 ksi and a yield strength of 36 ksi.

Atchison Engineers suggested an A27 70-40 steel alloy with a higher yield strength.

- A27 (70-40) has a maximum of 0.25% carbon and 1.20% manganese with an ultimate tensile strength of 70 ksi and a yield strength of 40 ksi.

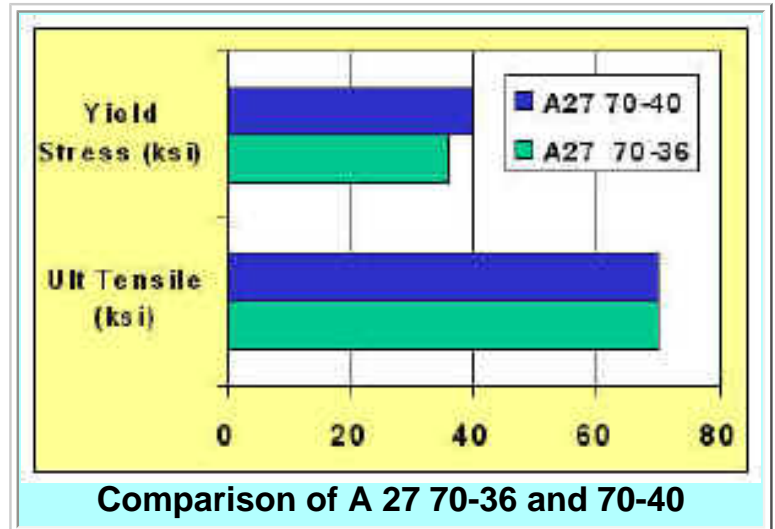

- The A27 70-40 was suggested as an alternative to A27 70-36, primarily for economic reasons. A batch melt of A27 70-40 was scheduled already for another job. Pouring off of a concurrent melt would save money.
 - ==>The A27 70-36 alloy would have required a separate melt with associated costs.
- The result was a component with higher yield strength and 15% lower material cost.





A Design Study in Steel Castings -- Pintle Socket

Pintle Socket Design and Features

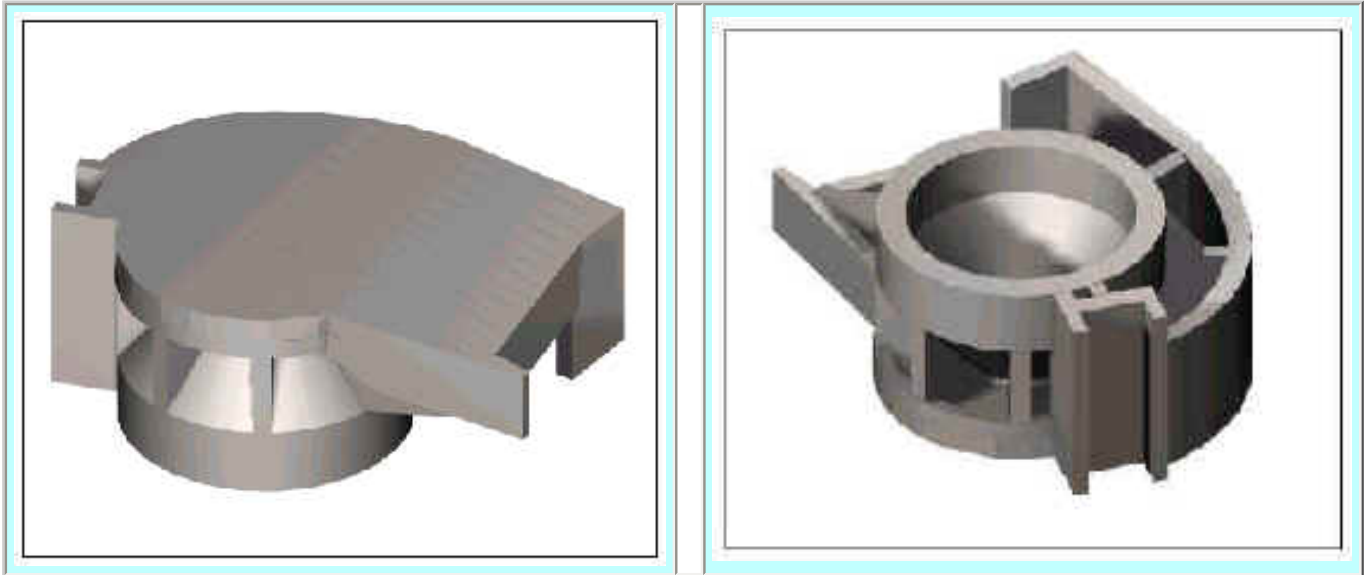

- The pintle socket is a casting with extensive ribbing, pockets, and functional flanges.
- The drawings show two different views of the pintle socket to show the overall size, the complexity, and the multiple features of the socket.
- The casting design engineer works with the OEM engineer to optimize the design for both performance and castability.



[Back](#) [Next](#)

[Return to SFSA Home Page](#)



Copyright 2001 by the Steel Founders' Society of America
All rights reserved.
Address comments to: blairr@sfsa.org
Last Modified: September, 2001 by STG



[Page 1](#)

In Cooperation with
[Atchison Casting](#)





A Design Study in Steel Castings -- Pintle Socket

Designing for Castability

Cooperative Engineering -- The foundry engineer and the equipment design engineer have to establish communication and a cooperative relationship in developing a design that has the optimum performance and value.

It is good practice to review the original design to ensure that it takes advantage of the benefits of the foundry process and avoids the design features that produce problems in metalcasting.

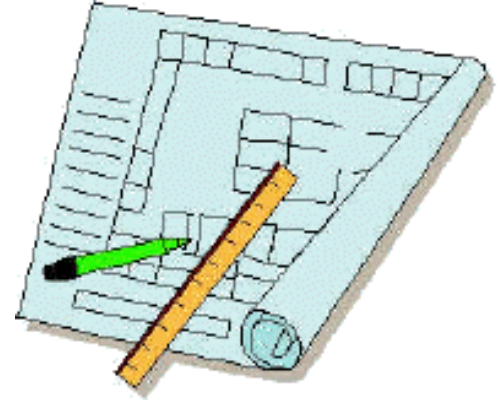

Atchison Casting received engineering drawings which showed the final form, fit and function for the pintle socket. The foundry engineers and the design engineers converted these drawings to "casting" drawings which included --

- > Fillets, radii, and fill at corners, joints, and gaps for control of mold configuration, metal flow, and strength improvement.
- > Added metal stock for machined surfaces.
- > Draft (for mold release) and taper (for directional solidification) on critical features. -> Feed stock risers to provide molten metal fill into solidification shrinkage.



[Back](#) [Next](#)

8

[Return to SFSA Home Page](#)



Copyright 2001 by the Steel Founders' Society of America
All rights reserved.
Address comments to: blairr@sfsa.org
Last Modified: September, 2001 by STG



[Page 1](#)

In Cooperation with
[Atchison Casting](#)





A Design Study in Steel Castings -- Pintle Socket

Design Feature Analysis

The design features (holes, ribs, pockets, flanges, etc.) on the component are produced by duplication of the features in the molds and cores

In designing for large castings in sand molds, it is important to review the design to eliminate or change those features that require thin and/or long sections in the sand molds/cores.

Thin/long mold features are fragile and can break during mold assembly and/or pouring.

The casting engineer should consult with the OEM design engineer to determine what features can be modified for improved castability without negative impact on component functionality or performance.



[Return to SFSA Home Page](#)



Copyright 2001 by the Steel Founders' Society of America
All rights reserved.
Address comments to: blairr@sfsa.org
Last Modified: September, 2001 by STG



In Cooperation with [Atchison Casting](#)



A Design Study in Steel Castings -- Pintle Socket

Feature Analysis for Mold/Core Design

The drawing to the right shows the pintle socket with three features highlighted for design review.

Which features need to be redesigned to reduce the possibility of mold/core breakage?

Feature A -- Pocket between Drive Bracket Flange and the Bowl Rim

Feature B -- Pockets between Supporting Ribs and Bowl.

Feature C -- Long Cavity in Extended Flange

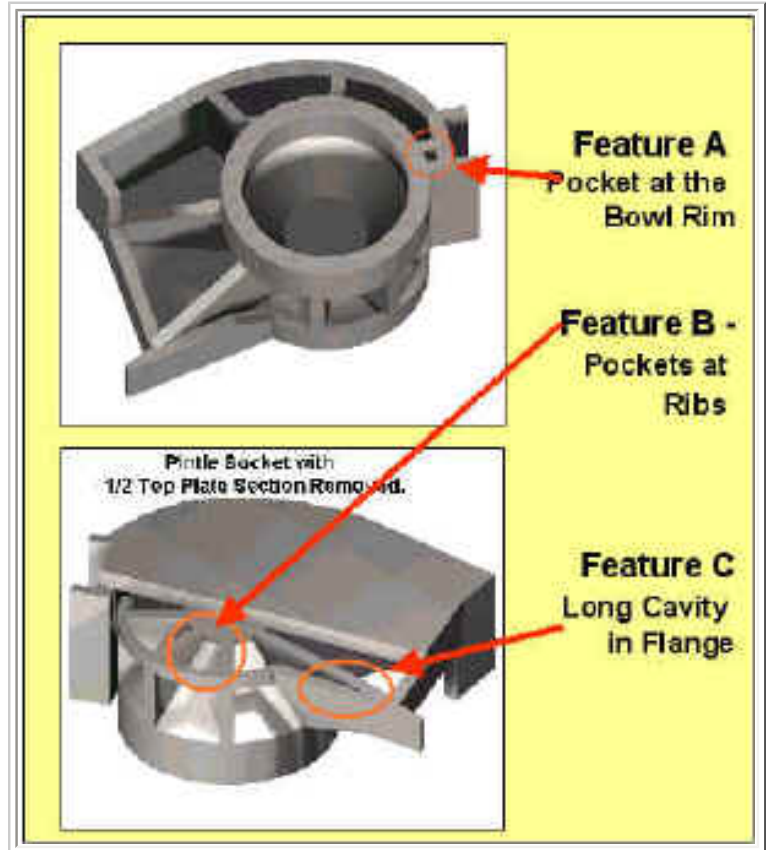

Choose the Feature/s (Feature A, B, or C) which should be redesigned to reduce mold/core breakage.



[Back](#)

10

[Return to SFSA Home Page](#)



Copyright 2001 by the Steel Founders' Society of America
All rights reserved.
Address comments to: blairr@sfsa.org
Last Modified: September, 2001 by STG



[Page 1](#)

In Cooperation with [Atchison Casting](#)



Feature A - Bowl Rim Pocket

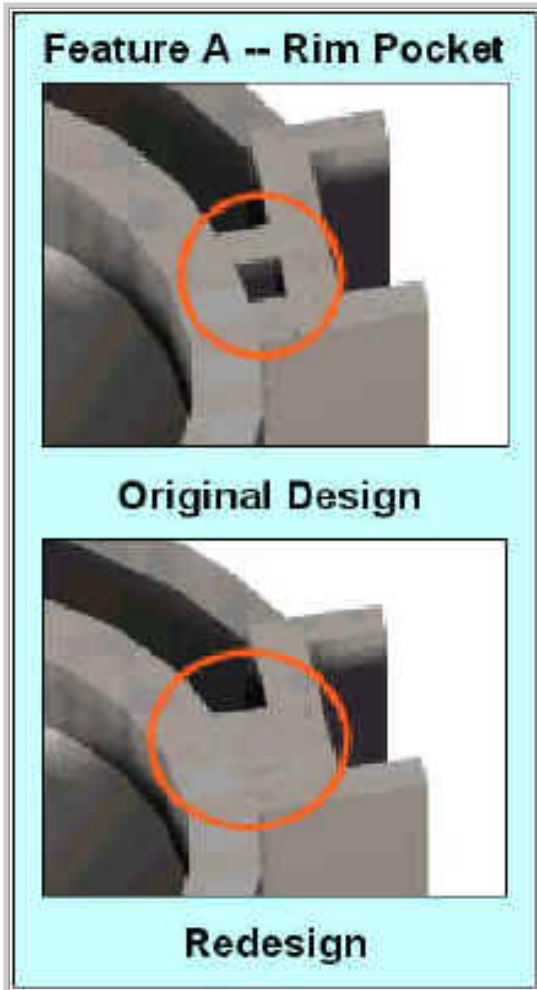

- In Feature A, the narrow pocket between the bowl rim and the bracket flange would be produced by a thin plate extension on the sand mold.
- That thin extension would be vulnerable to breakage because of its small cross-section.
- The flange and bowl should be redesigned to eliminate the pocket and form a solid junction between the bowl rim and the flange.

This not only reduces the chance of mold breakage; it also increases the bending resistance of the flange.

Feature A does need to be changed

***Choose another feature or
Go on to the next design issue.***



[Back](#) [Next](#)

11

[Return to
SFSA
Home
Page](#)



Copyright 2001 by the
Steel Founders' Society of America
All rights reserved.
Address comments to: blairr@sfsa.org
Last Modified: September, 2001 by STG



[Page 1](#)

*In Cooperation with
[Atchison Casting](#)*



Component Orientation

- In mold design for castings, the orientation of the part in the mold is an important factor in producing a sound casting.
 ==> Casting defects, when they occur, favor the cope or upper surface of gravity castings.
 ==> Critical surfaces should be designed so that are molded in the drag or the lower section of the casting.
- The base rim and interior bowl of the socket bowl are precision machined critical features.
- The casting design engineer has two options for orienting the bowl.

Option A -- The bowl feature is oriented up in the mold.

Option B -- The bowl feature is oriented down in the mold.

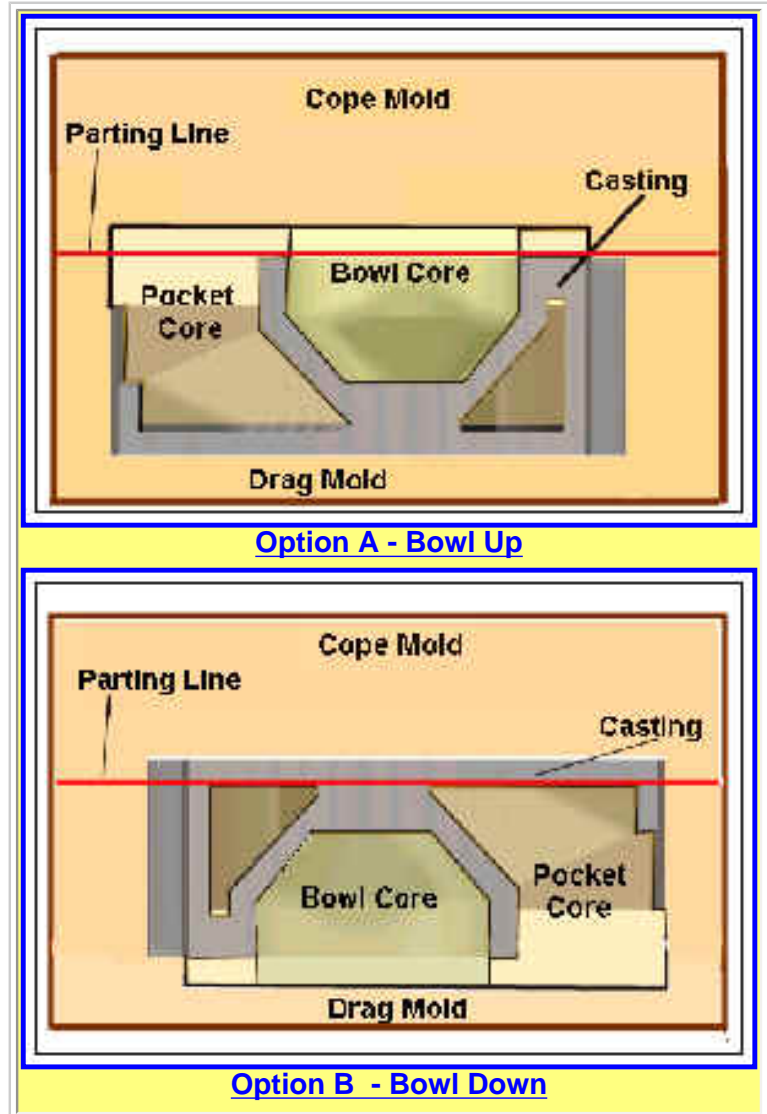

Choose the Orientation Option (Option A or B) which will optimize the soundness in the machined rim of the bowl



[Back](#)

14





A Design Study in Steel Castings -- Pintle Socket

Option A - Bowl Oriented Up

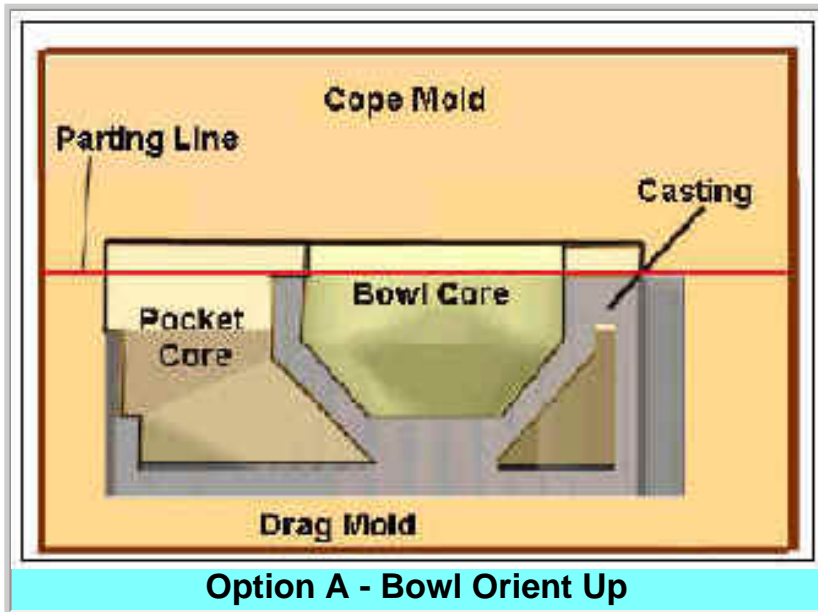

- In Option A, the bowl is oriented with the rim up in the cope, formed by the bowl core.
- But, if inclusions or voids form, they will segregate in this orientation in the top of the casting and be trapped in the rim and interior surface of the bowl.
- This increases the chances for flaws in the machined surface of the bowl.

==> In addition, the cores for the bowl and the rib pockets will be sitting high in the mold and will be more difficult to position and secure in the cope.

For this reason, Option A is not the best mold design.
[Go Back to the Options Page](#)



[Back](#)

15

[Return to SFSA Home Page](#)



Copyright 2001 by the Steel Founders' Society of America
 All rights reserved.
 Address comments to: blairr@sfsa.org
 Last Modified: September, 2001 by STG



[Page 1](#)

In Cooperation with [Atchison Casting](#)



A Design Study in Steel Castings -- Pintle Socket

Option B - Bowl Oriented Down

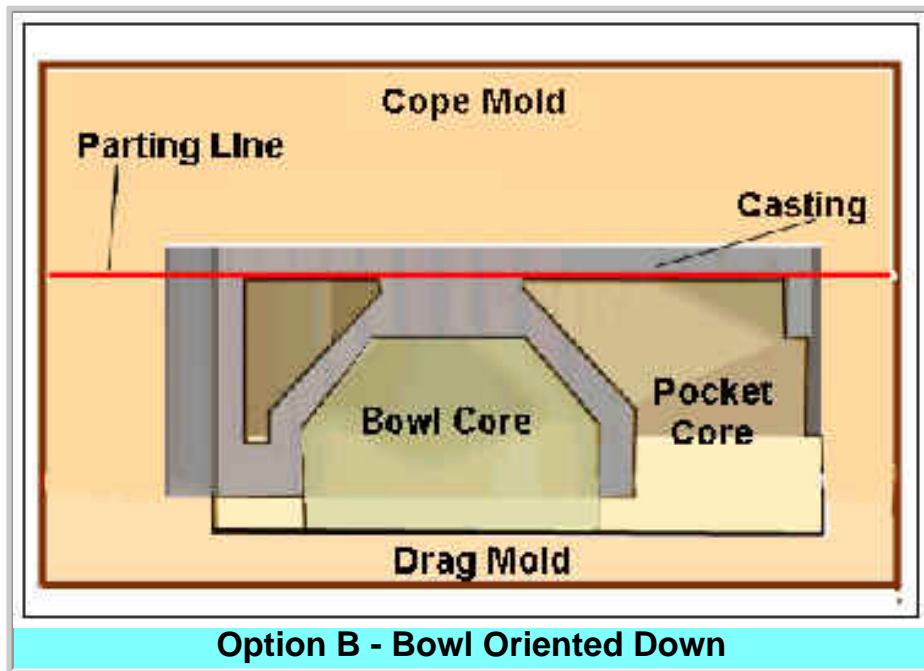

- In Option B the bowl is oriented with the rim down in the drag and formed by a core sitting in the base of the drag mold.
- If inclusions or voids form, they will segregate in the top of the casting in the top plate. The rim and interior of the bowl will be free of inclusions and will machine cleanly.

==> In addition, the cores for the bowl and the rib pockets will be positioned securely in the drag mold.

For these reasons, Option B is the best mold design.
[Go to the Next Design Issue](#)





Riser Design

The risers in the top mold (the cope) serve as reservoirs to feed molten metal into the casting during solidification and to control and trap solidification shrinkage voids.

- **Proper design (location, number, and size) of the risers is critical to prevent shrinkage voids in the casting.**
- **The risers must provide metal feed into all the sections of the casting.**
- **Ideally, all sections of the casting will receive sufficient feed metal to solidify without shrinkage voids. The risers will be the last to solidify.**
- **The drawing to the right shows the 10 risers feeding into the top plate of the pintle socket.**

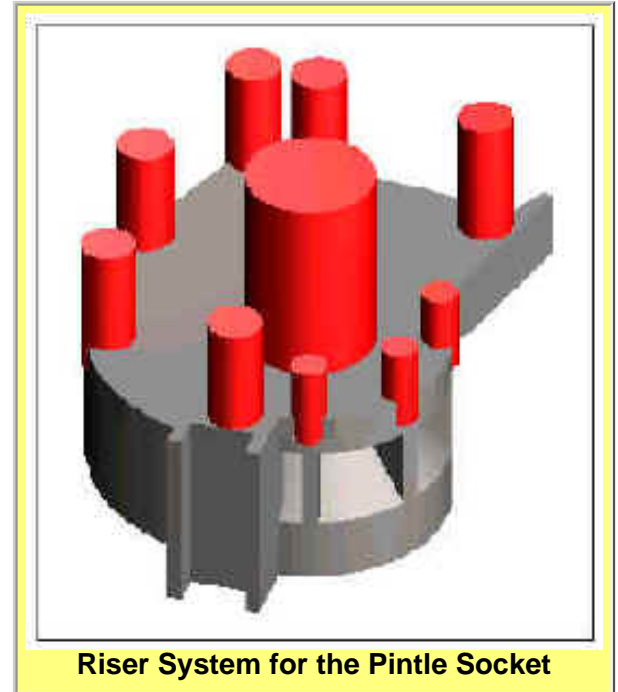

[Back](#) [Next](#)

17

[Return to SFSA Home Page](#)



Copyright 2001 by the Steel Founders' Society of America
All rights reserved.
Address comments to: blairr@sfsa.org
Last Modified: September, 2001 by STG



[Page 1](#)

In Cooperation with
[Atchison Casting](#)





A Design Study in Steel Castings -- Pintle Socket

Solidification Control

The foundry engineer uses chills to produce sound castings by controlling thermal gradients and the location and direction of solidification in the casting.

- A chill is a block of material (sand or metal) which has a high heat capacity and/or thermal conductivity, which accelerates the rate of heat extraction in a critical area of the casting.

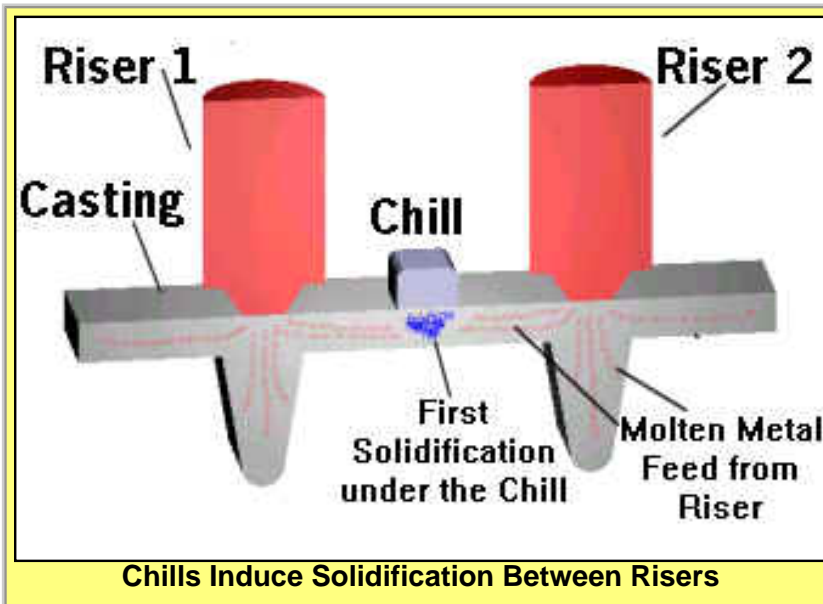

Chills placed on a wall or plate sections will improve the effectiveness of the riser in feeding molten metal to the casting.

- The chill produces an “end-effect” (a portion of the casting that solidifies first) that insures that directional solidification occurs between risers.
- This insures that the risers feed into the casting and don’t feed into each other.



[Back](#) [Next](#)

18

[Return to SFSA Home Page](#)



Copyright 2001 by the Steel Founders' Society of America
All rights reserved.
Address comments to: blairr@sfsa.org
Last Modified: September, 2001 by STG



[Page 1](#)

In Cooperation with [Atchison Casting](#)



Solidification Control

- With the thick (1 3/4") top plate of the pintle socket oriented up in the mold, it is important to use chills to initiate solidification at the remote sections of the plate, so that the risers will feed effectively. The drawings to the right show two options for placing the chills.
- [Option A](#) - Chills over the rib sections between the risers
- [Option B](#) - Chills at the center of the plate sections between the risers and ribs.

**Choose the chill location
(Option A or Option B)
which will maximize the riser feed and
produce a sound casting.**

Option A -- Chills over the Ribs

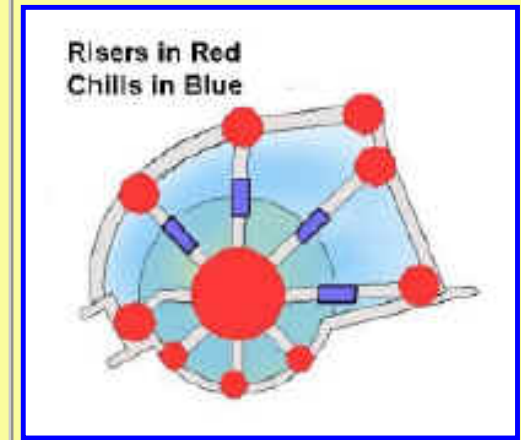

Option B - Chills over the Centers

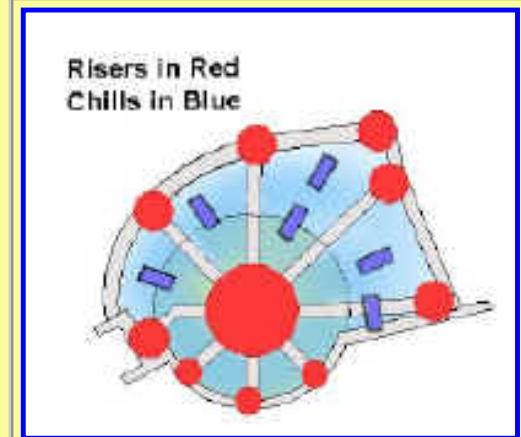

[Back](#)

19

[Return to
SFSA
Home
Page](#)



Copyright 2001 by the
Steel Founders' Society of America
All rights reserved.
Address comments to: blairr@sfsa.org
Last Modified: September, 2001 by STG



[Page 1](#)

In Cooperation with
[Atchison Casting](#)



Option A - Chills over the Rib Sections

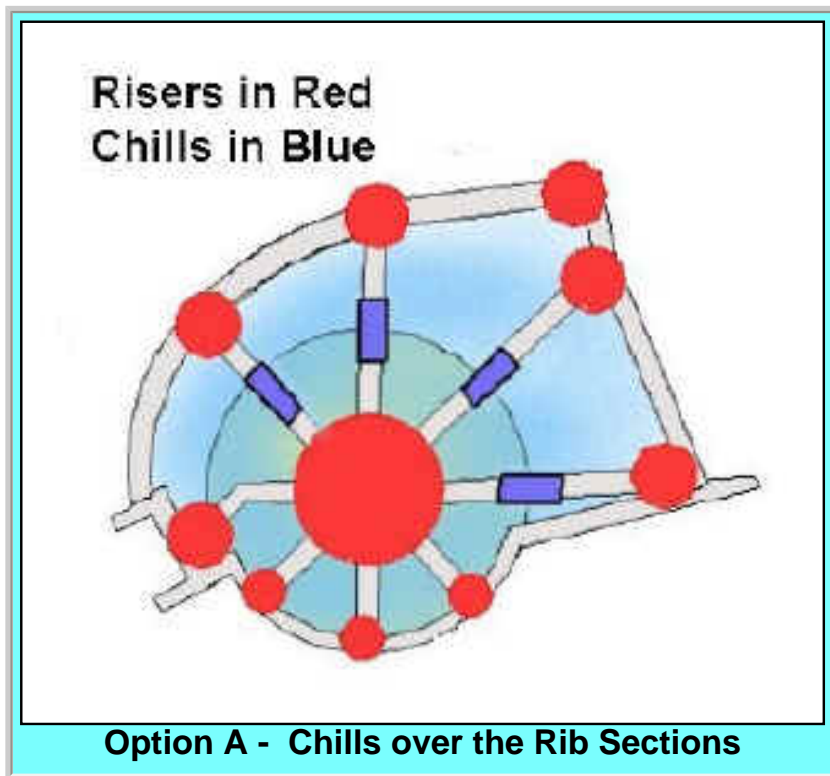

In Option A, the chills are over the rib sections between the risers.

These chill locations are not optimal -

- *The thicker rib sections will freeze early and restrict molten metal feed into the lower sections of the ribs.*
- *With chills over the ribs, the center sections of the plates may solidify late and be isolated from the risers.*
- *Without sufficient molten metal feed from the risers, solidification shrinkage may form in the top plate and the ribs.*

Option A is not the best chill location design.
[Go Back to the Options Page](#)



[Back](#)

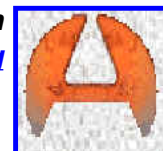

Option B - Chills over the Center Plate Sections

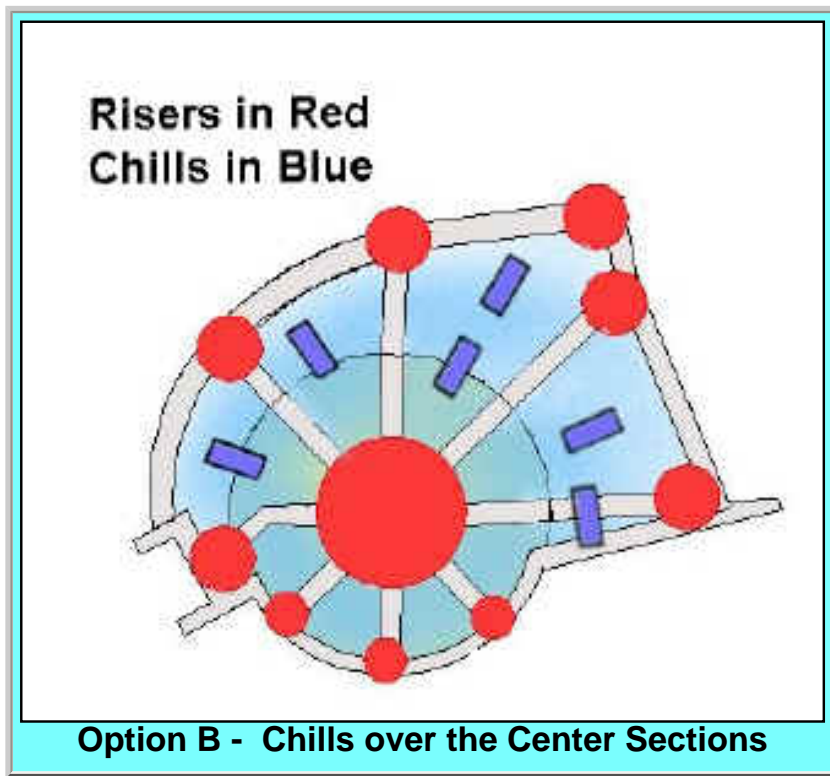

In Option B, the chills are positioned over the flat plate sections between the risers and the ribs.

These chill locations are well designed.

- *The solidification will be quickly initiated in the thinner center sections of the top plate.*
- *The risers will feed easily and effectively into the top plate sections.*
- *Solidification shrinkage will be captured in the risers producing a sound top plate.*

Option B is the best chill location design.
Go on to the Next Design Issue



[Back](#) [Next](#)

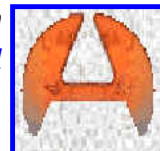

Machining Considerations

All cast metal shrinks during solidification. If molten metal from the risers cannot reach isolated areas of the casting, shrinkage voids will occur. The voids tend to be located in the center third of the casting section -- the region which solidifies last.

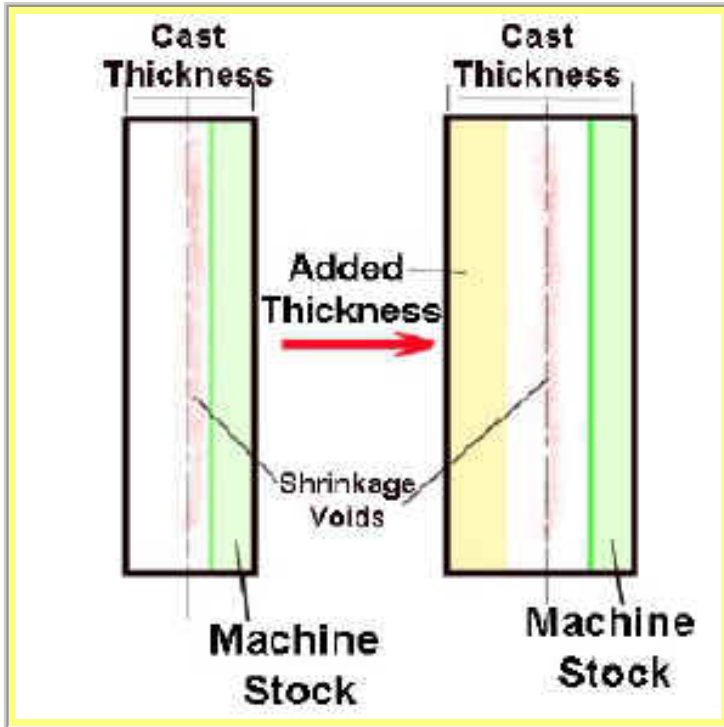

In metal casting, it is prudent to evaluate thin wall sections that have machining requirements to insure that, if shrinkage voids occur, they will not be close to the inner face of the machining stock.

- *As a guideline, the machining stock should be less than 1/3 of the casting thickness.*
- *If the machining requirement is large on thin walls and solidification modeling shows potential center shrinkage problems, extra thickness may be added to the opposite side to "pull" the center line shrinkage away from the machine stock*



[Back](#) [Next](#)

22

[Return to SFSA Home Page](#)



Copyright 2001 by the Steel Founders' Society of America
All rights reserved.
Address comments to: blairr@sfsa.org
Last Modified: September, 2001 by STG



[Page 1](#)

In Cooperation with [Atchison Casting](#)





A Design Study in Steel Castings -- Pintle Socket

Machining Considerations

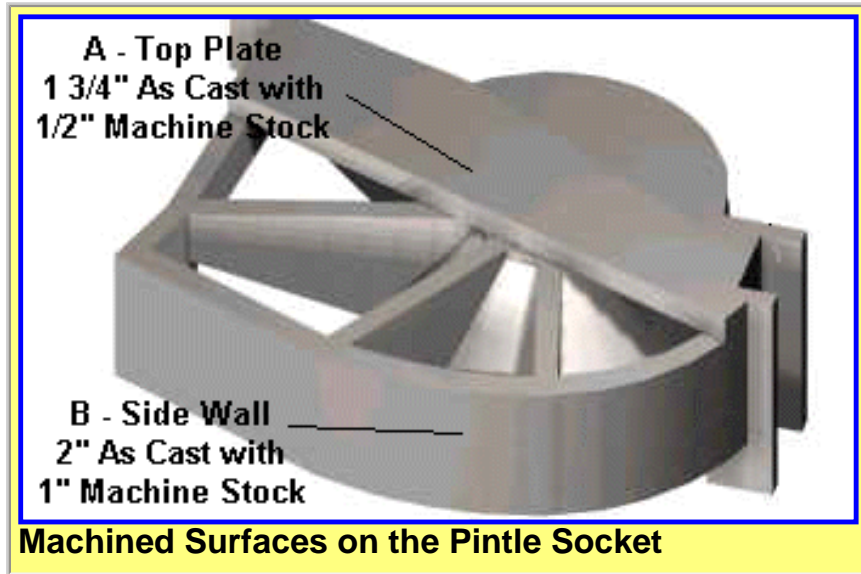

The drawing to the left shows two surfaces on the pintle socket that require rough and finish machining.

- These surfaces act either as joining surfaces or as bearing surfaces.

The drawing shows the selected machined surfaces with original as-cast wall thickness including machine stock.

Which surface/s (Surface A or B) should be analyzed and redesigned to keep centerline shrinkage away from the finished machine surfaces?



[Back](#)

23

[Return to](#)
[SFSA](#)
[Home](#)
[Page](#)



Copyright 2001 by the
Steel Founders' Society of America
All rights reserved.
Address comments to: blairr@sfsa.org
Last Modified: September, 2001 by STG



[Page 1](#)

In Cooperation with
[Atchison Casting](#)





A Design Study in Steel Castings -- Pintle Socket

Surface A -- Top Plate

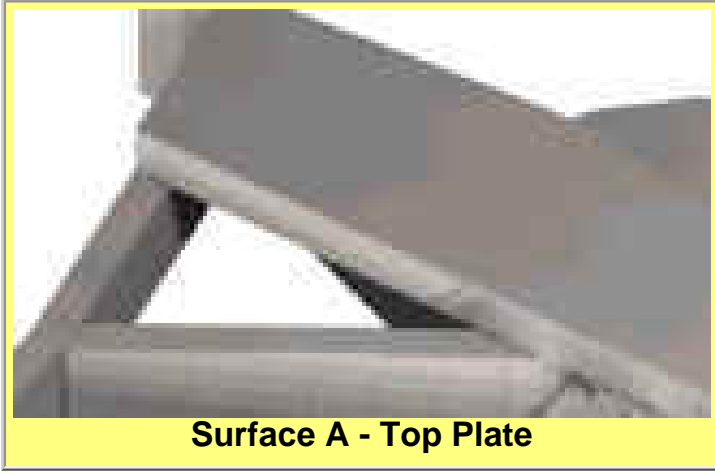

Surface A - Top Plate

- Surface A -- The top plate is cast with a thickness of 1 3/4" including 1/2" of machining stock.
- With 1 3/4" cast thickness and with machining stock of 1/2", the machined thickness is 1 1/4" thick. The inner machined surface is outside the center one third of the cast cross section.

No additional thickness needs to be added to the top plate.

Surface A does not need additional thickness.
[Go back and choose another feature](#) or
[Go on to the next design issue.](#)



[Back](#) [Next](#)

24

[Return to](#)
[SFSA](#)
[Home](#)
[Page](#)



Copyright 2001 by the
 Steel Founders' Society of America
 All rights reserved.
 Address comments to: blairr@sfsa.org
 Last Modified: September, 2001 by STG



[Page 1](#)

In Cooperation with
[Atchison Casting](#)



Rigging Design

The rigging system (downsprues, runner, and ingates) serves as the flow path for molten metal into the mold cavity.

- Proper design of the rigging system is critical to provide for uniform, controlled metal flow into the mold.
 - ==> Non-uniform, long path, and/or slow metal flow may produce unfilled sections or solidification shrinkage in the casting.
 - ==> Excessively rapid metal flow or metal splashing will cause mold/core erosion and oxidation of the steel, producing non-metallic inclusions in the casting.
- The pintle socket casting is rigged with a side sprue connected to four runners feeding into four ingates located around the base of the large bowl.
 - ==> The rigging is illustrated in the drawing to the right.

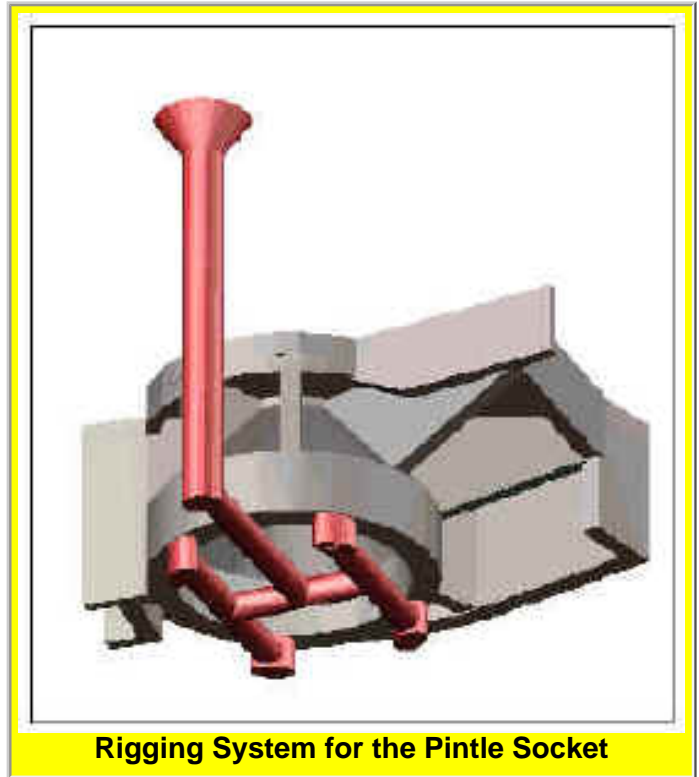

[Back](#) [Next](#)

26

[Return to](#)
[SFSA](#)
[Home](#)
[Page](#)



Copyright 2001 by the
Steel Founders' Society of America
All rights reserved.
Address comments to: blairr@sfsa.org
Last Modified: September, 2001 by STG



[Page 1](#)

In Cooperation with
[Atchison Casting](#)





A Design Study in Steel Castings -- Pintle Socket

Patterns for the Pintle Socket

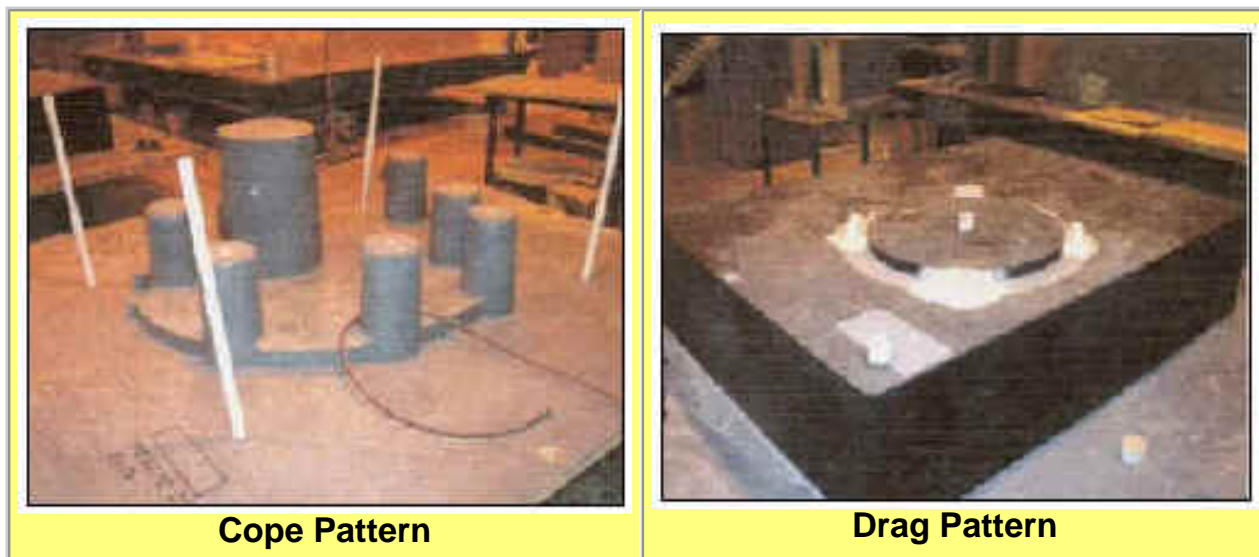

Cope Pattern

Drag Pattern

- The cope and drag patterns for the pintle socket were CNC machined in hardwood for strength, durability, and cost control.
- The photos above show the patterns for the top/cope mold and the bottom/ drag mold
 - *The cope pattern shows the seven of the ten risers and the four vents.*
 - *The drag pattern shows the core print for positioning the bowl core and the four ingates into the bowl rim.*
- The cope and drag molds are formed in the patterns with “no-bake” sand (a binder-sand mixture with superior strength to green sand)



[Back](#) [Next](#)

27

[Return to](#)
[SFSA](#)
[Home](#)
[Page](#)



Copyright 2001 by the
Steel Founders' Society of America
All rights reserved.
Address comments to: blairr@sfsa.org
Last Modified: September, 2001 by STG



[Page 1](#)

In Cooperation with
[Atchison Casting](#)

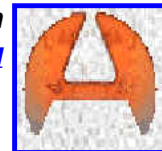

Cores for the *Pintle Socket*



Core Box for the Bowl



Core Box for the Rib Pockets

- The two core boxes were machined in hardwood for strength, durability, finish, and cost.
- The photos above show the core boxes for the bowl core and for the rib pockets (which forms all eight ribs in the casting).
- The cores are also produced in “no-bake” sand.



[Back](#) [Next](#)

28

[Return to
SFSA
Home
Page](#)



Copyright 2001 by the
Steel Founders' Society of America
All rights reserved.
Address comments to: blairr@sfsa.org
Last Modified: September, 2001 by STG



[Page 1](#)

In Cooperation with
[Atchison Casting](#)



A Design Study in Steel Castings -- Pintle Socket

Machined Pintle Socket



Machine Pintle Socket Bowl



Machined Top Plate

After solidification is complete, the casting is -

- *Removed from the flask and cleaned of sand in the shake-out process.*
- *Surface cleaned by shot blasting.*
- *Cut and trimmed to remove the rigging and the risers.*
- *Heat treated with a normalization and a tempering.*
- *Finish cleaned and trimmed by grinding.*
- *Visually inspected and evaluated by ultrasonics.*
- *Quality checked for dimensions.*
- *Sent out for rough and finish machining.*



[Back](#) [Next](#)

29

[Return to SFSA Home Page](#)



Copyright 2001 by the Steel Founders' Society of America
All rights reserved.
Address comments to: blairr@sfsa.org
Last Modified: September, 2001 by STG



Page 1

In Cooperation with [Atchison Casting](#)





A Design Study in Steel Castings -- Pintle Socket

Pintle Socket

Lessons Learned

Atchison Casting produced four pintle sockets (and other castings) for the hinge system and delivered them to the Oregon Iron Works for machining and assembly.



The successful production of the pintle socket illustrates --

- *The use of collaborative engineering between the foundry and the buyer to optimize the pintle socket design for performance and castability.*
- *The use of chills to control solidification, producing a sound casting and optimizing casting yield.*
- *The consideration of foundry melt scheduling to reduce material costs for the buyer.*



[Back](#) [Next](#)

[Return to SFSA Home Page](#)



Copyright 2001 by the Steel Founders' Society of America
All rights reserved.
Address comments to: blairr@sfsa.org
Last Modified: September, 2001 by STG



[Page 1](#)

In Cooperation with
[Atchison Casting](#)





Summary

Pintle Sockets for a River Lock Gate

The four pintle sockets for the gates on the new McAlpine locks (U.S. Army Corps of Engineers) on the Ohio river were produced and delivered by Atchison Casting with high quality and cost savings.



Barge and Boat in a River Lock



For further information on the design and production of this and other steel castings, contact -- Mike Weaver at Atchison Casting, Phone-- 913-367-2121, FAX -- 913-367-2130, E-mail -- mlw@atchcast.com
Web Site = <http://www.atchisoncasting.com>

Acknowledgment --

The metalcasting design studies are a joint effort of the American Foundry Society and the Steel Founders' Society of America. Project funding was provided by the American Metalcasting Consortium Project, which is sponsored by the Defense Logistics Agency, Attn: DLSC-T, Ft. Belvoir, VA 22060-6221



The End

[Back One](#)

[Return to SFSA Home Page](#)



Copyright 2001 by the Steel Founders' Society of America
All rights reserved.
Address comments to: blairr@sfsa.org
Last Modified: September, 2001 by STG



[Page](#)

[Atchison Casting](#)





A Design Study in Steel Castings -- Pintle Socket

Surface B -- Side Wall

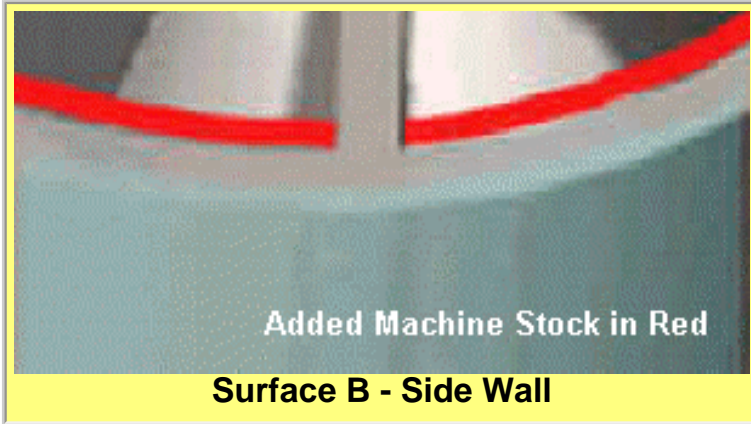

- Surface B -- The side wall was originally designed as a 2" thick wall including the 1" of machining stock.
- The 2" thickness with the 1" machining stock gives only 1" of finished thickness. This leaves the inner machine surface in the center third of the as-cast wall.

The thickness of the wall should be increased on the inside by 1" to 3". This keep the inner face of the machining stock outside the center third of the wall thickness.

Surface B needs 1" additional thickness.
[Go back and choose another feature](#) or
[Go on to the next design issue.](#)



[Back](#) [Next](#)

25

[Return to](#)
[SFSA](#)
[Home](#)
[Page](#)



Copyright 2001 by the
 Steel Founders' Society of America
 All rights reserved.
 Address comments to: blairr@sfsa.org
 Last Modified: September, 2001 by STG



[Page 1](#)

In Cooperation with
[Atchison Casting](#)





Feature B - Rib Pocket

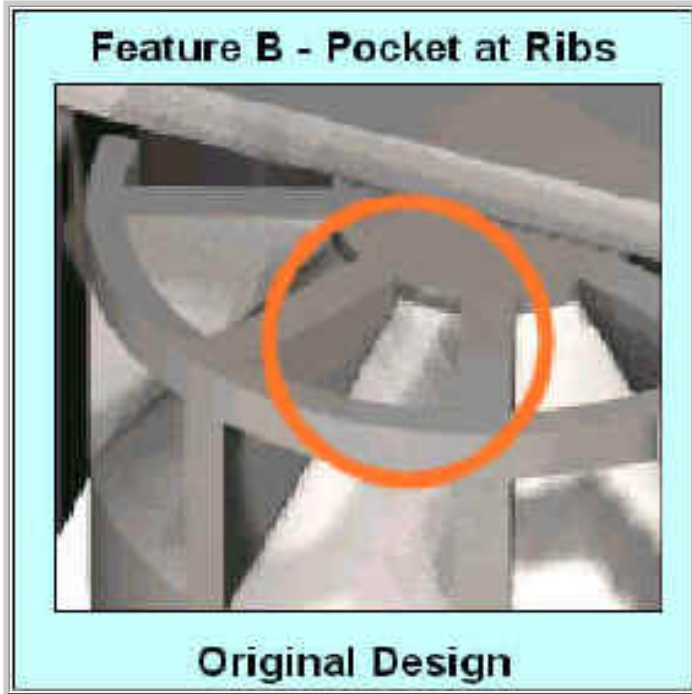

- In Feature B, the pockets formed at the junction of the socket bowl and the reinforcement ribs are not particularly long or thin.
- The features on the sand core that form the pocket will not be particularly fragile.
- The rib pocket does not need to be redesigned.

Feature B does not need to be changed.
Choose another feature or Go on to the next design issue.



[Back](#) [Next](#)

[Return to SFSA Home Page](#)



Copyright 2001 by the Steel Founders' Society of America
All rights reserved.
Address comments to: blairr@sfsa.org
Last Modified: September, 2001 by STG



[Page 1](#)

In Cooperation with
[Atchison Casting](#)



Feature C - Flange Pocket

Feature C - Flange Pocket



Original Design



Redesign

- In Feature C, the extended length of the open pocket would be produced by a thin arm on the sand core.
- That thin arm would be vulnerable to breakage because of its length and its small cross-section.
- Feature C should be redesigned to reduce the length of the pocket.

This not only reduces the chance of core breakage; it also strengthens the flange.

Feature C does need to be changed

**Choose another feature or
Go on to the next design
issue.**



[Back](#) [Next](#)

13

[Return to
SFSA
Home
Page](#)



Copyright 2001 by the
Steel Founders' Society of America
All rights reserved.
Address comments to: blairr@sfsa.org
Last Modified: September, 2001 by STG



[Page 1](#)

*In Cooperation with
[Atchison Casting](#)*

